

THE AE DRAWING HANDBOOK

De-mystifying the Craft of Making Excellent Drawings

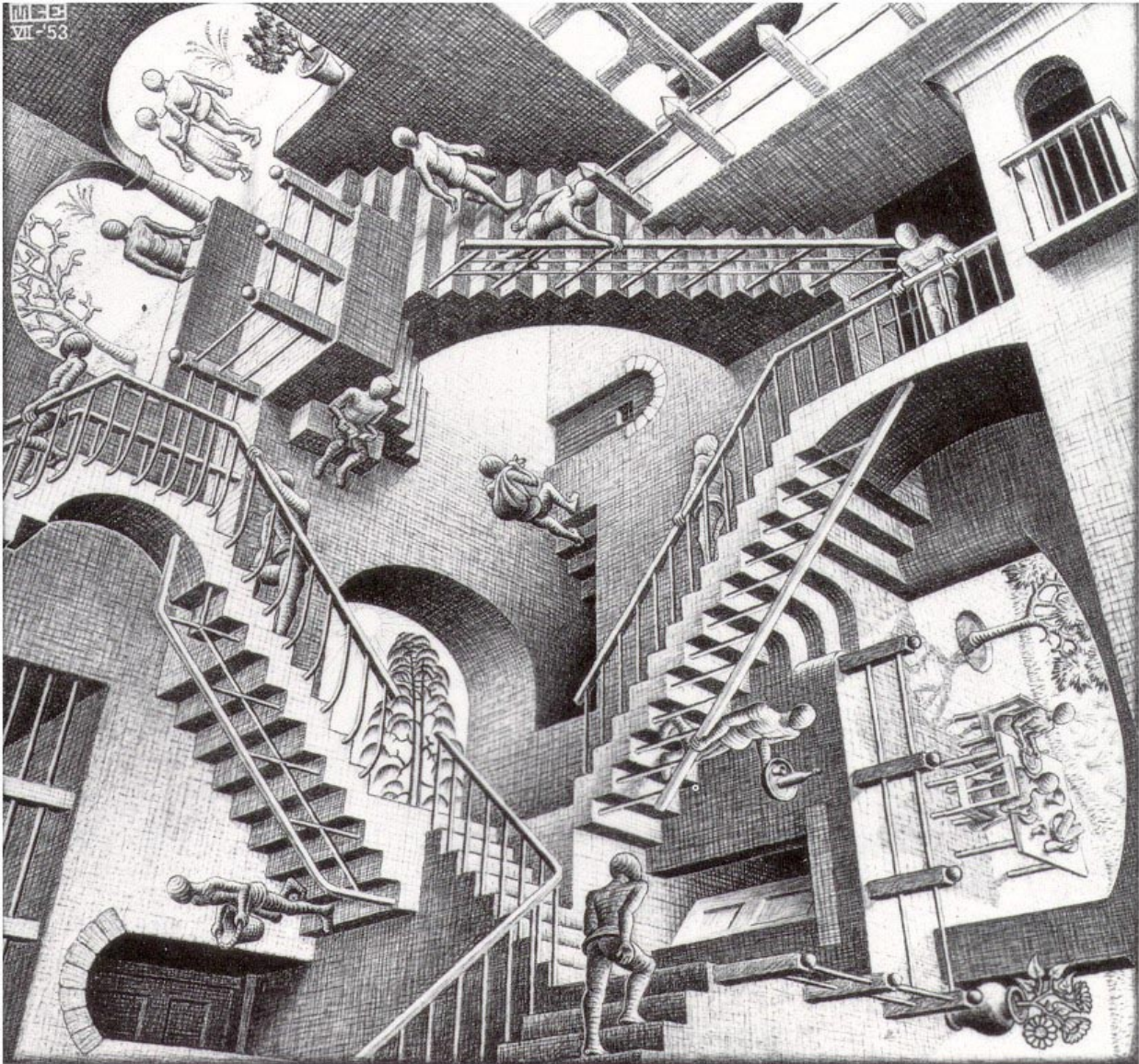

an engraving by M.C. Escher

FIRST EDITION: September 2022

ARCHITECTURAL ENGINEERING | UNIVERSITY OF WATERLOO, ONTARIO, CANADA

WHY A DRAWING HANDBOOK?

Drawings are the **primary** means of communication between the members of any design team. They explain:

- Concepts
- Materials
- Sizes and layouts
- Range from distant to very close views
- Include dimensions as well as words

Drawings MUST follow *universal drawing conventions*. In an office environment many different people will work on the same drawing. Drawings are shared between different consulting offices as well. Cloud computing and drawing programs such as Revit allow collaboration between the architect, engineer and consulting members. There is no place for unusual approaches to hatching, for instance, as it will result to misunderstandings about the material make-up of the project. Worst case scenario, a lawsuit.

Whether drawing by hand or by computer, the same rules apply.

THE MORE QUICKLY YOU BECOME ADEPT AT DRAWING WELL, THE EASIER STUDIO BECOMES!

We decided to produce this drawing guide as an inordinate amount of crit and grading time is wasted in simply marking up drawings to correct their formatting. Much like learning proper spelling and grammar, or correct formatting of mathematical equations, drawings also must follow standards in production.

FORMAT OF THE GUIDE

The guide will provide you with a short checklist of the necessary ingredients for each drawing type plus a sample drawing to provide a visual target of what your drawing should look like. Do NOT copy any technical details that you might see in the drawings as they are likely not to match your own project requirements. They are provided so that you can look at the nature of the linework, hatching, dimensions, notes, etcetera included in each drawing type.

WHAT CONSTITUTES A COMPLETE DRAWING SET?

This will vary from project to project as relates to the physical size of the project and to what level of detail you are tasked with development. Each of your AE studios has a different focus and so there may be more or more specific drawings required based on the focus.

Generally you need to include:

- Site plan
- Ground floor plan
- Second and above floor plans
- Roof plan
- Elevations of all sides (usually 4)
- Sections through the building in each direction (cross section and longitudinal section)

For more detailed projects you will also add:

- Framing plans
- Detailed sections (showing materials)
- Enlarged details (showing exactly how all of the pieces attach together)

Further requirements:

- Renders and views
- 3D drawings – axonometric/isometric or perspective

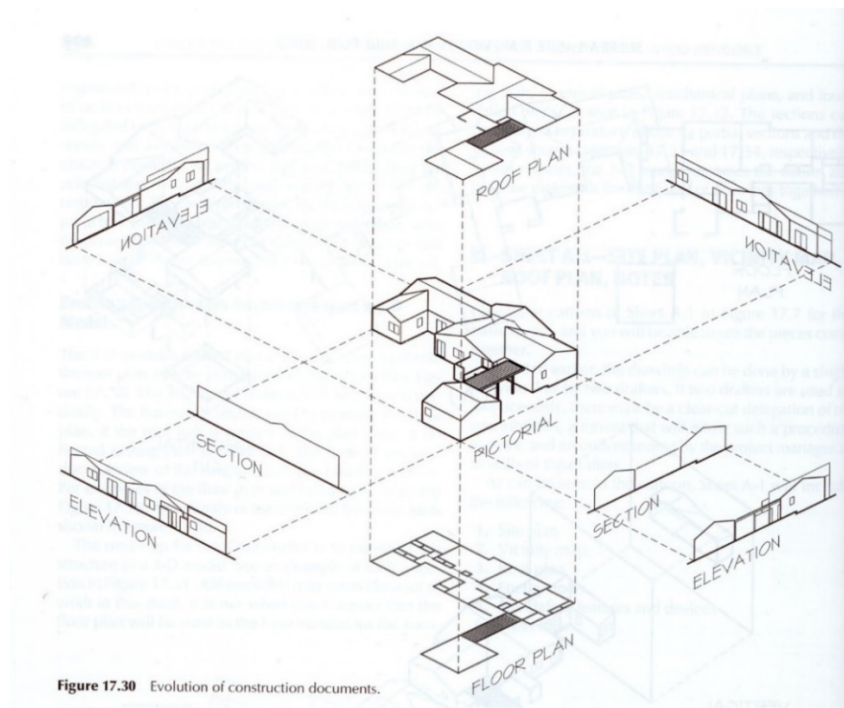

Architectural Working Drawings by Wakita and Linde

This 3D view describes the relationship between all of the views in the base drawing set.

LAYING OUT THE DRAWINGS

It is important when you are conceiving a drawing set to understand the scale at which the drawing is to be executed and the size of paper for printing. For AE studios the common paper size is 24" x 36".

It is advisable to lay out the drawing to make efficient use of the page. Ensure that the sheet is well organized, that the drawings are aligned evenly, heights match, etc.

It costs money to print drawings and so you want to be efficient and not float single details on the page if it is avoidable.

Planning your set in advance using a cartoon method will save you a headache at crit time.

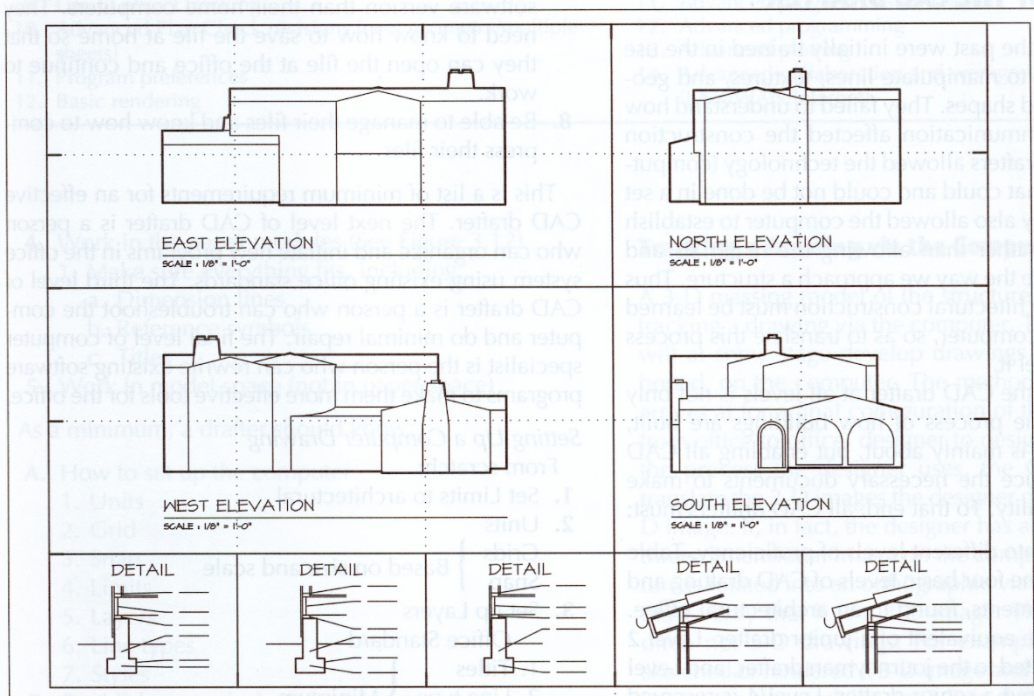



Figure 3.30 Sample cartoon/page layout. (Courtesy of Mike Adli, Owner; Nagy R. Bakhoun, President of Obelisk Architects.)

TITLE BLOCK AND SHEET INFORMATION

Technical drawing sets will always have a title block strip at the right hand side of the page.

The sheet information must include:

- North arrow (exclude from non plan view sheets)
- Name of drawings included on the sheet
- Scale if the scale of all the drawings on the sheet are the same
- Sheet number – this is needed so that details, sections that reference another sheet can be located
- Your name(s) as authors of the drawing
- Date

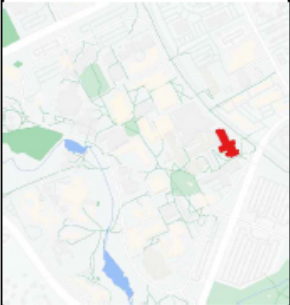
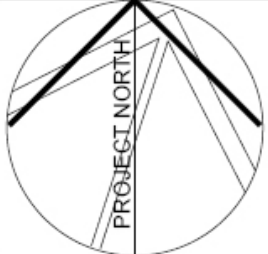
 UNIVERSITY OF WATERLOO 200 UNIVERSITY AVENUE WEST WATERLOO, ONTARIO, N2L 3G1 519-888-4567		
KEYPLAN		
		
2	08/29/22	ISSUED FOR GUIDE
1	07/27/22	ISSUED FOR REVIEW
NO.	DATE	REVISION
		
PROJECT		
<p style="text-align: center;">AE DRAWING GUIDE</p>		
DRAWING TITLE		
<p style="text-align: center;">SAMPLE TITLE BLOCK</p>		
DATE:	DRAWING NO.	
08/29/2022	A0.0	
SCALE:		
AS NOTED		
DRAWN BY:		
RC		

LETTERING ON THE DRAWING

Lettering on a drawing is done using ALL CAPS. When drawings were done by hand this allowed many people to work on a sheet over time and not have it look an utter mess. In computer drawings you are choosing a standard font that appears the same as the traditional hand lettering style. Generally we are looking at plain vertical lettering.

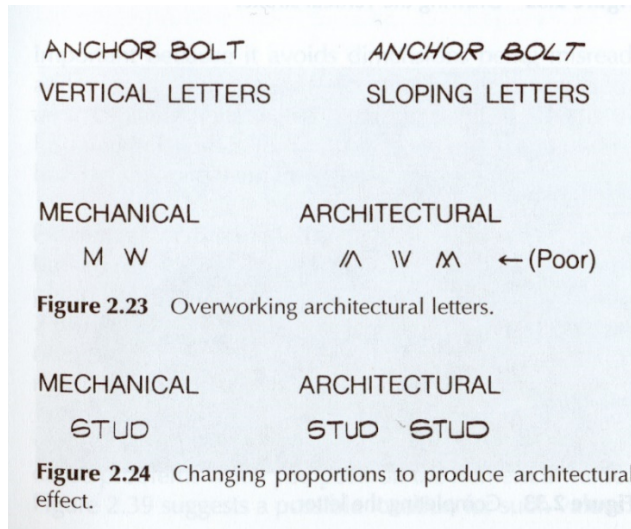

EXAMPLE:
B L I T R K

Figure 2.25 Emphasis on certain strokes.

EXAMPLE:
B O Q D P

Figure 2.26 Spaces incorrectly left within letters.

EXAMPLE:
PLYWOOD PLYWOOD
(Poor) (Good)

Figure 2.27 Producing consistency.

EXAMPLE:
PLYWOOD PLYWOOD
(Good) (Poor)

Figure 2.28 Importance of good spacing.

PLYWOOD PLYWOOD
(Poor) (Good)

Figure 2.29 Full use of guidelines.

Architectural Working Drawings by Wakita and Linde

When drawing by hand make very light horizontal guide lines on the page to ensure your spacing is even and the quality is clean.

When creating drawings on the computer use a very plain font such as Arial, again using ALL CAPS except for some specialized notations.

DIFFERENTIATING LINE WEIGHTS

It is very important to change up the weight or thickness of the lines when you are drawing. You must also show the presence of building components *above* or *behind* as they impact your decisions. These would include in the plan view the lines of roof overhangs, ridge lines for pitched roofs and skylights.

Lineweights are differentiated, whether you are drawing in ink or pencil, by hand or with CAD.

Heavy line when cutting through a material to define the outside.

Lighter lines to show elements in elevation, or further away.

Even lighter lines still for hatching or objects further in the distance.

Dashed lines to show objects above you.

Dotted lines to show hidden lines.

The precise nature of dashed and dotted lines will vary depending on the type of drawing you are preparing. Centre lines, easement lines, property lines, etc all use variations of “non solid” line types.

Changing the **line weights** makes the drawing read more clearly.

Heavy outline where cut in section

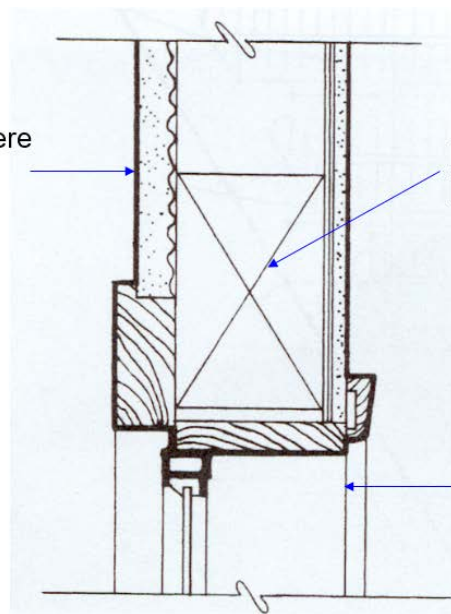

Lighter lines for hatching

Lighter lines to show materials “beyond”

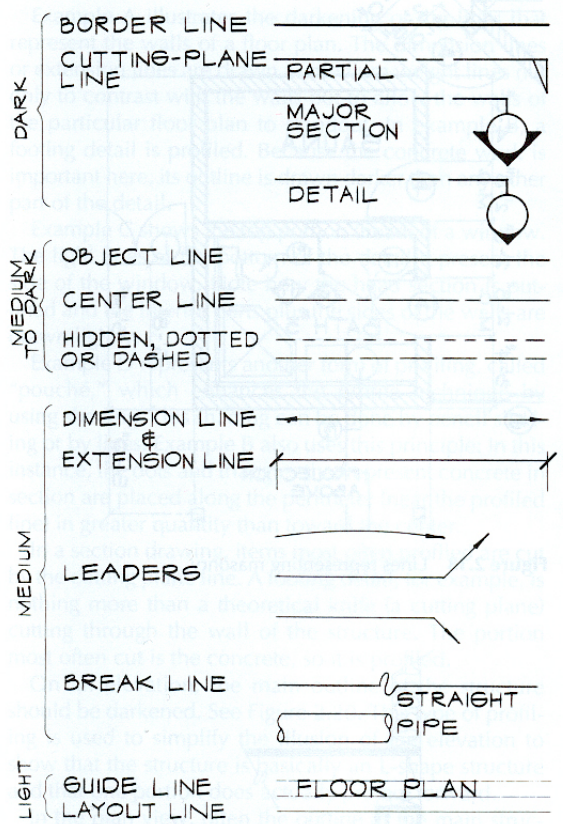

Figure 2.14 Vocabulary of architectural lines.

There are many different types of lines to be found on technical drawings. Some of the variations are pretty subtle, but different versions of dotted and dashed lines are needed to be associated with so many different parts of the drawing.

These may look slightly different in CAD produced drawings than hand drawn ones.

Regardless it is necessary to make some lines thicker and bolder looking and others quite light.

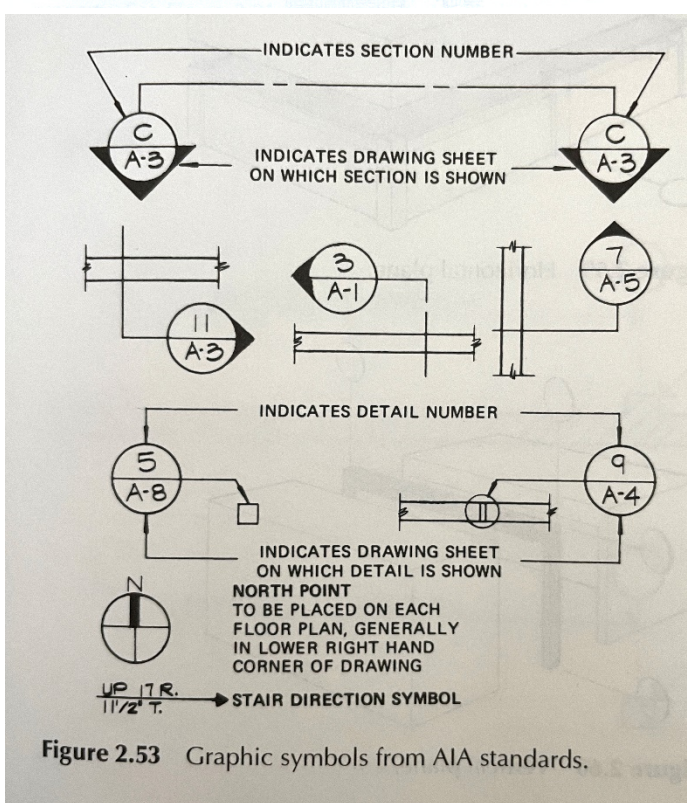

Figure 2.53 Graphic symbols from AIA standards.

Bubbles are used to note where sections and details are taken. The letter or number in the top half of the bubble is the designation of the detail/section itself and the A-3 type number on the bottom is the page number. That is why you have to number your pages.

When you call out a detail on a section, you will navigate to the page noted to find the detail.

The blackened in arrows show the direction of the view that the section takes. If you don't see an arrow, it refers to an enlarged detail that is located elsewhere in the drawing set.

HATCHING

There are 2 approaches to “filling in the walls” when creating DESIGN versus TECHNICAL drawings.

DESIGN DRAWINGS

Design drawings will normally completely fill the walls, floors in black. This is called **poché** and is used to make the solid elements really stand out clearly.

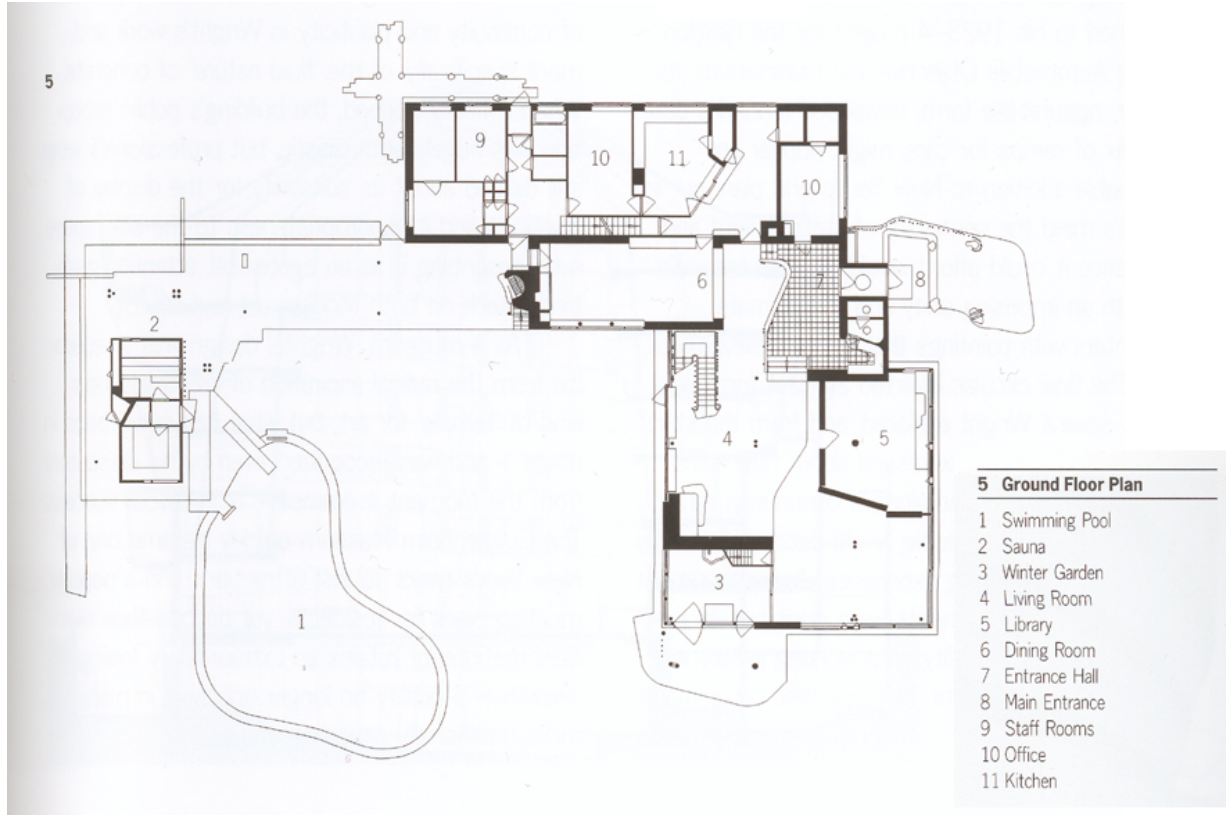

Key Buildings of the 20th Century by Weston

Notice that even though this is a DESIGN presentation drawing, the LOAD BEARING or exterior walls are visibly thicker than the interior partitions.

Hatch is used VERY SPARINGLY on plan drawings as it detracts from the clear reading of the walls, windows and door openings.

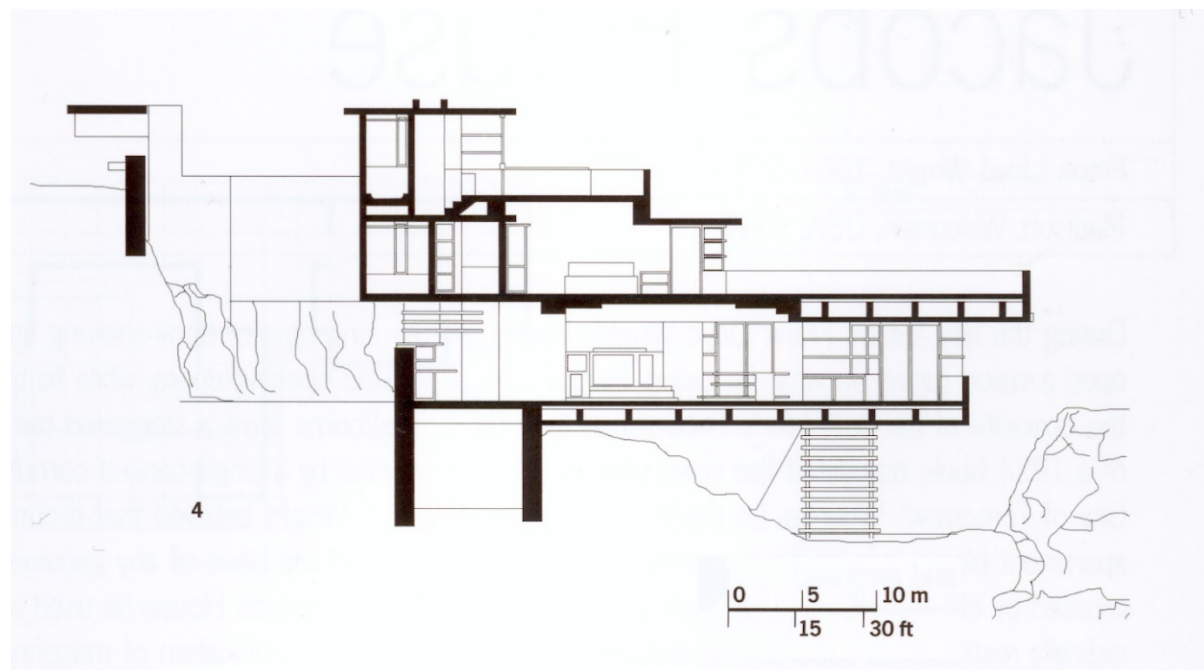

Key Buildings of the 20th Century by Weston

Sections for design drawings will also **poché** the walls and floors to make the structure stand out. These structural elements also have their approximate thicknesses represented. Very light lines are used to show the elements in elevation beyond. It is helpful to put scale figures (people) in these drawings to give a sense of the height of the space.

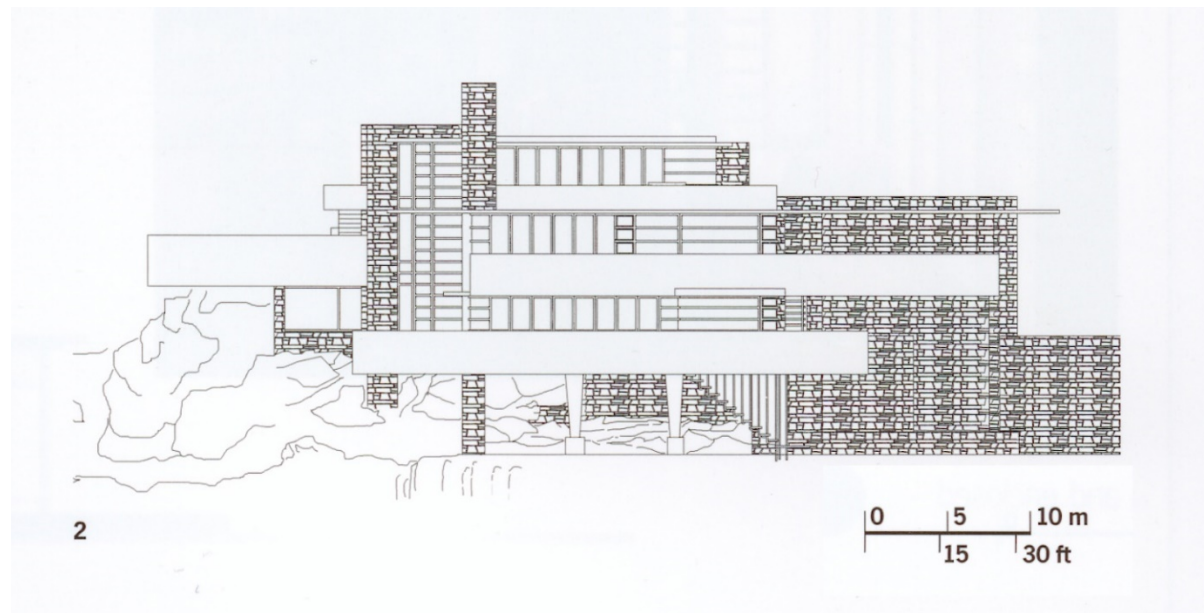

Key Buildings of the 20th Century by Weston

Elevations for design drawings will try to make the materials of the cladding read so that this is easily understood. Take care not to make the drawing look too cluttered by having the hatch too dense. Be sure if you are doing a CAD type drawing that the hatch does not go black when you reduce it to print.

TECHNICAL DRAWINGS

Technical drawings are also known as contract drawings and are generated so that the contractor can properly bid on the cost of the job and also accurately order all of the materials. Instead of blackening in the walls and floor with *poché* the lines representing the actual material layers are included. The nature of this will vary greatly depending on the scale of the drawing. If you are making a plan at 1:50 or a detail at 1:5 the amount of information that is possible to show will vary a lot!

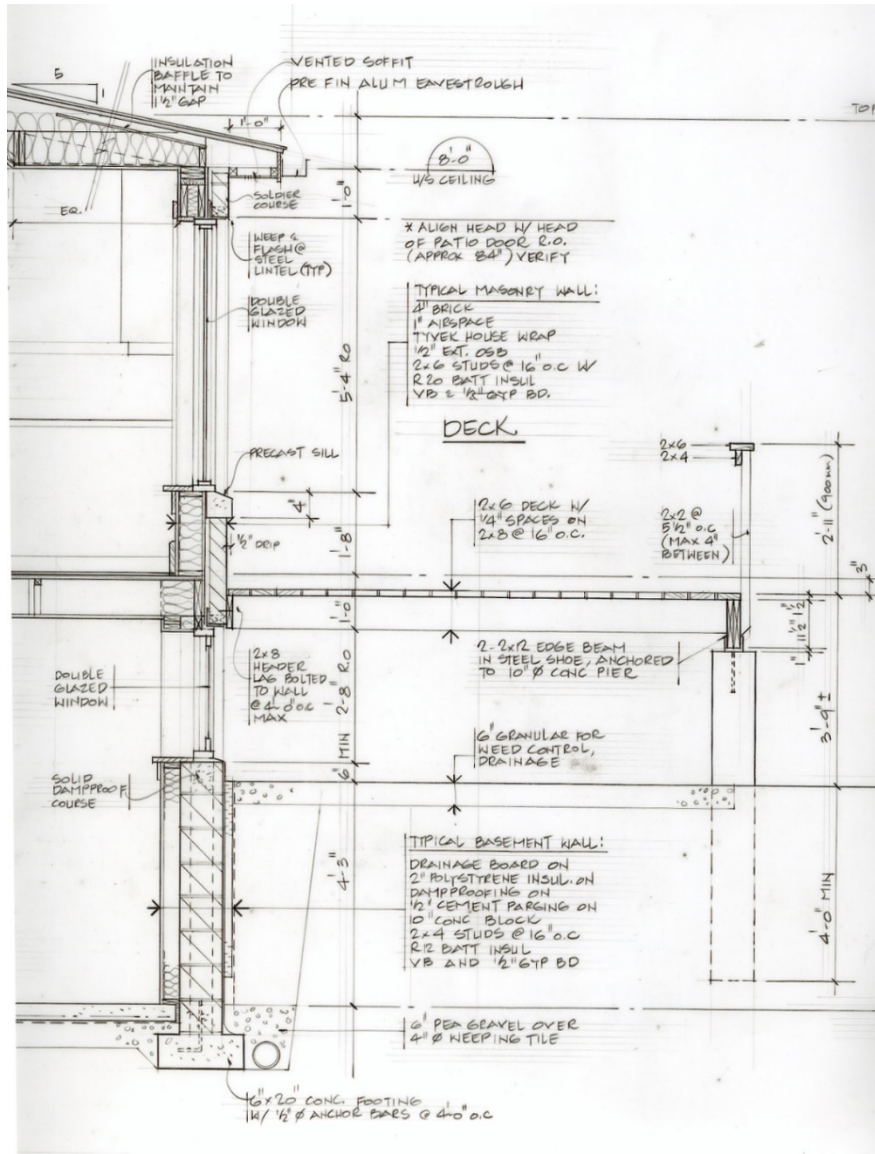

Hand drafting by Terri Boake

This hand drafted section through a house shows the nature of what level of material detail is possible at a scale of around 1:20. Drawings get quite intense by the time you include dimensions and materials labels so you have to be very organized when planning the drawing. Notice how the labels for the wall assemblies are created as "lists" rather than having a confusing spiderweb of arrows to each element. It makes the information much easier to understand.

HATCHING

Hatching is used instead of *poché* in technical drawings to provide clarity in the representation of your materials. It helps to understand the layering of walls, floors and roofs. Hatches are universally used in the industry and you should always use standard hatches. Do not invent something unique.

Be sure that the density of the hatch you use matches the scale of the drawing. If you are using AutoCAD or Revit, check to see that the printed out version of the drawing does not “go black” or become otherwise hard to read (see example below).

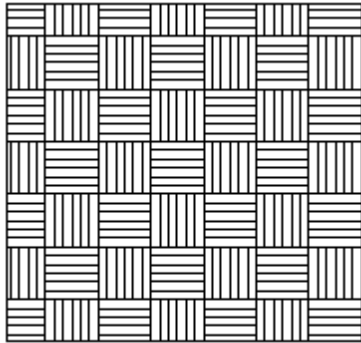

UNDISTURBED SOIL

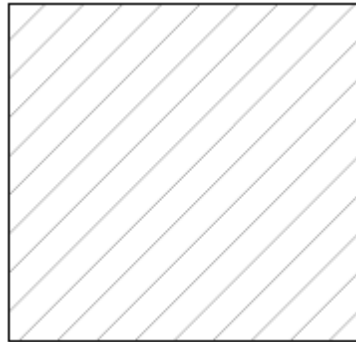

MASONRY

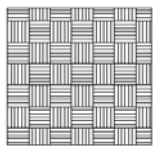

UNDISTURBED SOIL



MASONRY

When hatches are scaled down they can change appearance or become hard to read.

As a rule you should check the readability of your CAD based drawings at the scale you will be printing them at to make sure that they read properly.

Tone existing construction grey or a fine dotted hatch to make it clear that it is existing and not new construction.

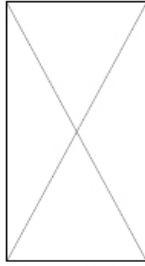

STRUCTURAL WOOD



FINISHED WOOD

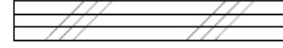

PLYWOOD



MASONRY



CONCRETE BLOCK



STRUCTURAL STEEL

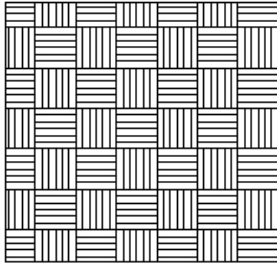

UNDISTURBED SOIL

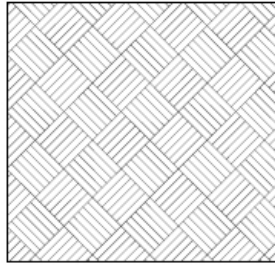

BACKFILL

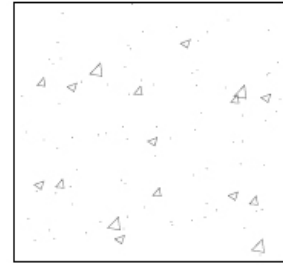

CONCRETE

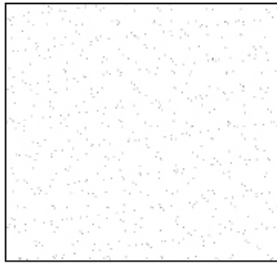

SAND

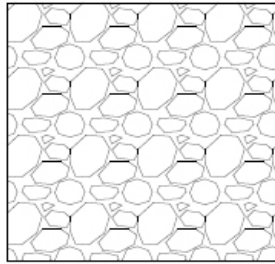

PEA GRAVEL



EXISTING STRUCTURE



RIGID INSULATION



SPRAY FOAM INSULATION

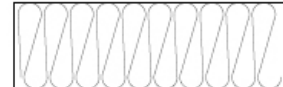

BATT INSULATION

GRID LINES

Larger buildings that use a column grid as a structural system will have a system of grid lines to locate the column grid and allow for ease of dimensioning and for the contractor to be able to easily reference a certain position in the large project. If they talk about the column at grid B1 on the third floor everyone knows which one they are talking about.

The grid goes through the CENTRE of the column or bearing wall so that if the column size or wall thickness changes it doesn't impact the grid placement and dimension string.

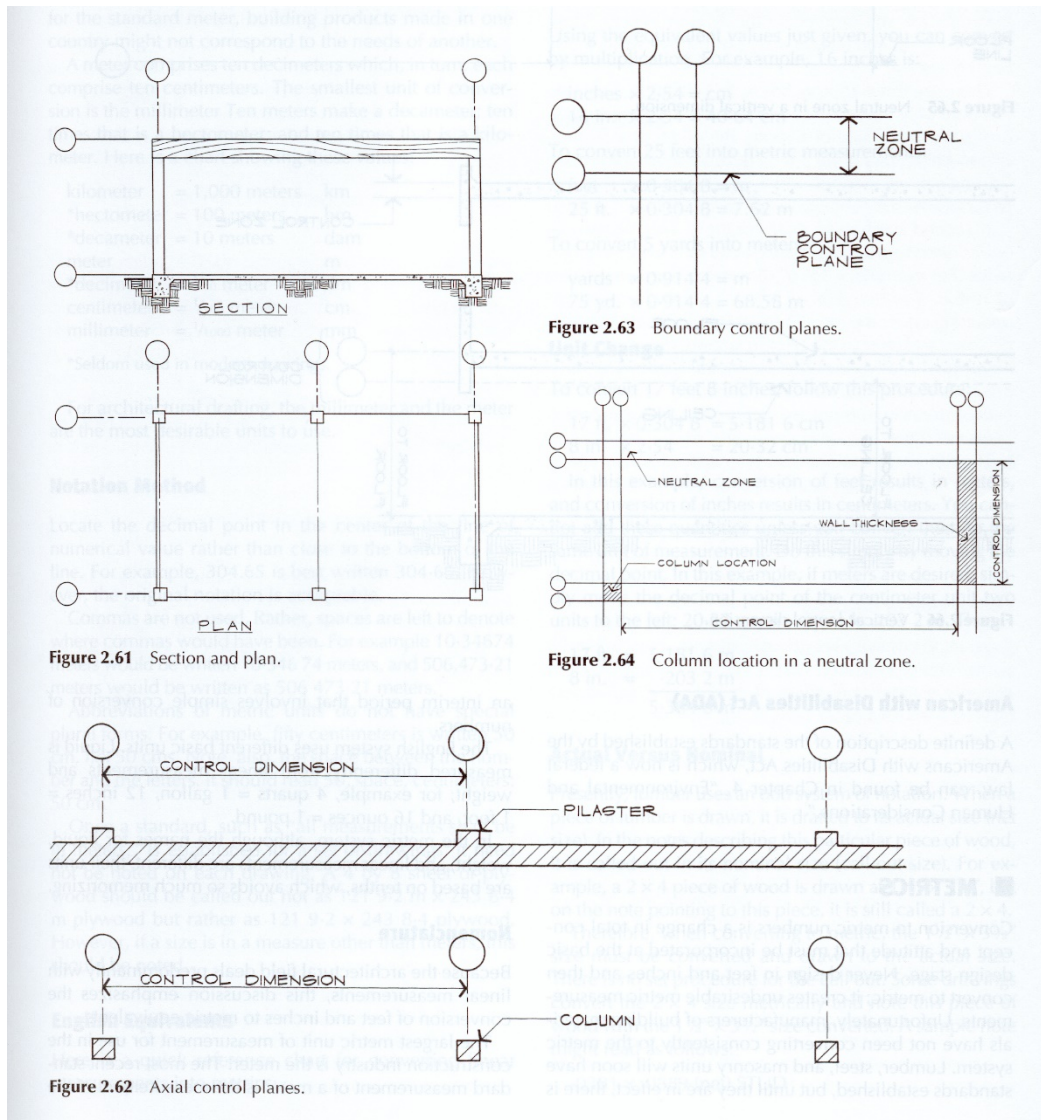

Architectural Working Drawings by Wakita and Linde

This is a very generic drawing of grid lines. Each has a round bubble into which goes the number or letter for the grid.

LABELLING DRAWINGS

It is critical that the text on your drawing is clear and well organized. The more complex the drawing, as in the partial section on this page, the more labels are required and the greater potential for a mess to occur!

When drawing on CAD be sure that your text size is correct for the final printed drawing. It should be neither too large nor too small. You will need to do a test print to get accustomed to picking the correct size.

Assembly type labels should be used for elements like walls, roofs and floors where we have a sandwich of layers. Spiderweb type criss-cross lines are not acceptable. Only use single arrow labels for unique elements. Do not make individual lines cross over each other. Line text up neatly!

For assemblies labels are:

- Outside to inside layers (walls)
- Top to bottom layers (floors, roofs)
- Include the material thickness, material name and R-value if needed (150mm fibreglass batt insulation, RSI 3)

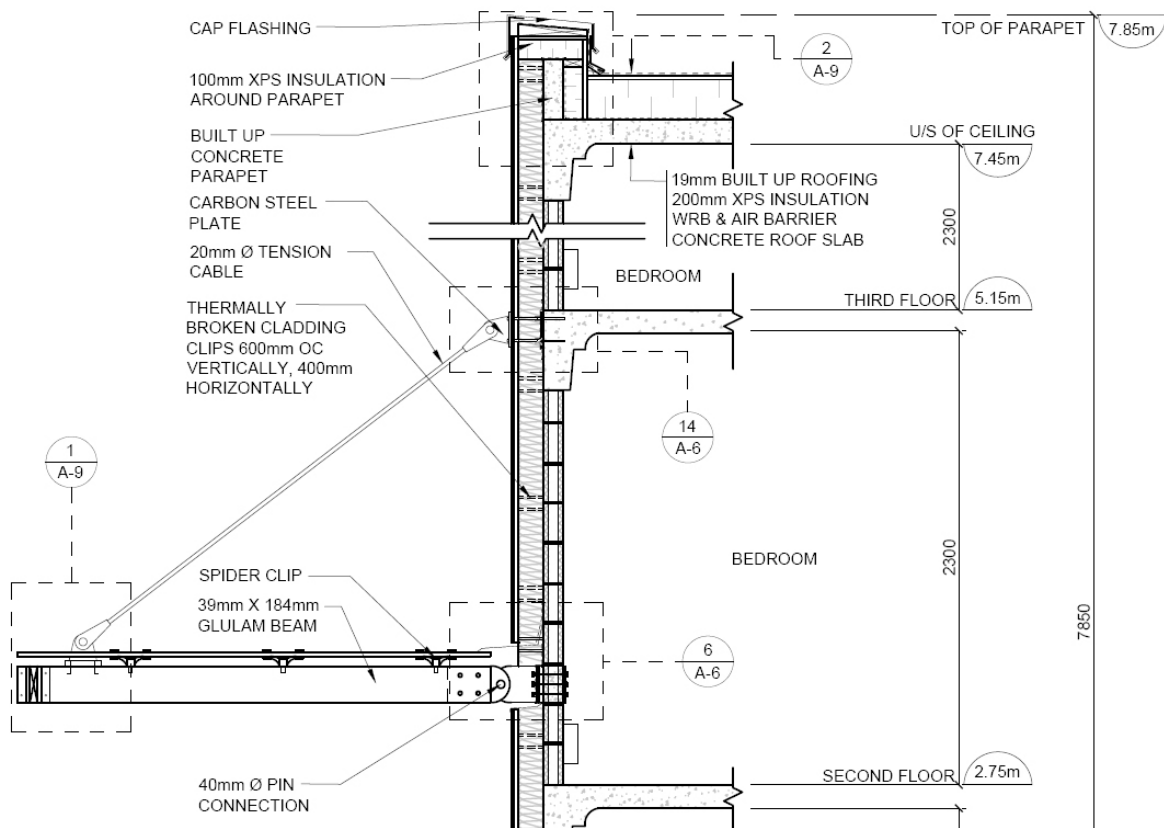

CAD drawing by Renee Champion

HOW TO DRAW DOORS IN PLAN

When we draw doors in the plan view we show how they open so that we can see:

- the type of door being used
- direction of travel
- that door swings do not interfere with traffic (overlapping other door swings, blocking vestibules for wheelchair access or hitting furniture)

Also note direction of door opening and make a point that *EXIT doors on public buildings always open in the direction of travel to let people out for fire reasons*. Residential doors open into the residence as it is assumed that your housemates will let you out in case of fire and also if snow is piled up outside you can open the door in and dig your way out.

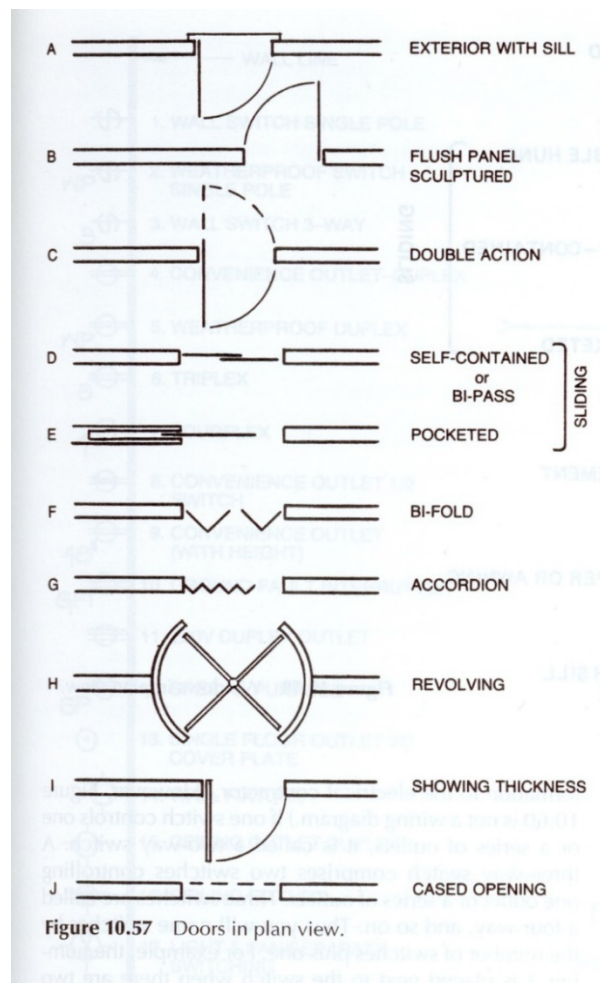

Figure 10.57 Doors in plan view.

Architectural Working Drawings by Wakita and Linde

In a design drawing the walls will be blackened in. In a technical drawing the walls will show their true thickness and you will also see the door frame, its position and a threshold if the door is in an exterior wall – showing a change in the flooring material from inside to outside.

HOW TO DRAW WINDOWS and DOORS IN ELEVATION

Elevation drawings will show windows and doors. As part of this you need to draw them correctly to indicate which are fixed (non-operable) and operable. We need to show how they open. Where is the hinge side? Is it a slider?

The hinge is located at the pointy side of the dashed lines that form a triangle. If we don't see those dashed lines, or the slider arrow indication, the panel is assumed to be fixed.

There is a double line around the opening to indicate the frame in the wall, and another line around the glass itself to show the frame that holds the glass.

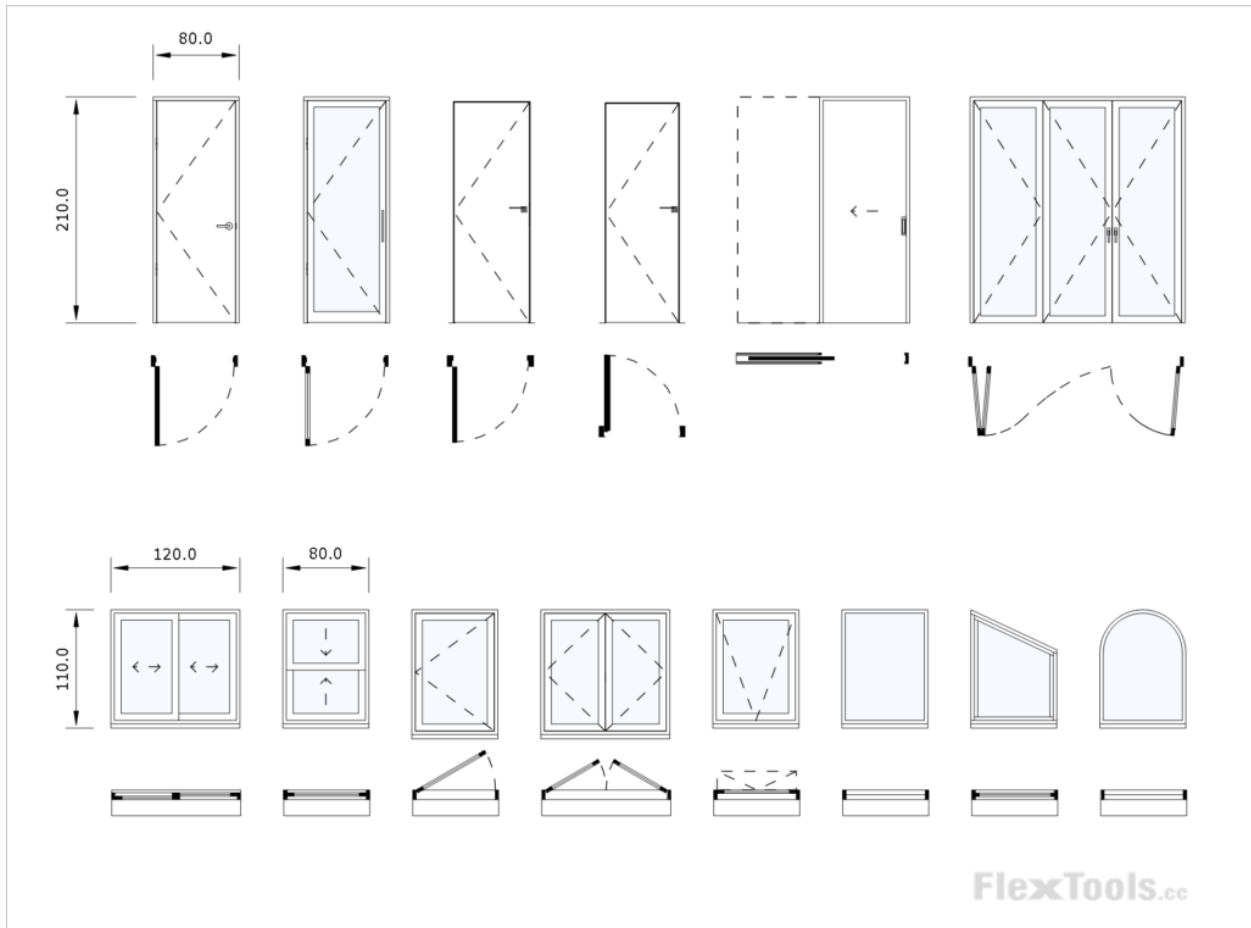

STAIRS

Stairs can be one of the more complex elements you include in your plans and sections. The number of treads needed depends on the height from floor to floor. There are strict codes regarding stairs to prevent tripping. Steps for stairs shall have a horizontal run of not less than 255 mm and not more than 355 mm between successive steps and shall have a vertical rise between successive treads not less than 125 mm and not more than 200 mm. *Normal stairs are generally 255 tread and 200mm riser.*

The width of the stair is related to how many people will be using it at one time. Can they comfortably pass by each other? Usually 1m is considered enough for a residential stair. Commercial and institutional buildings will have wider runs, up to 1.5m, due to high occupancy.

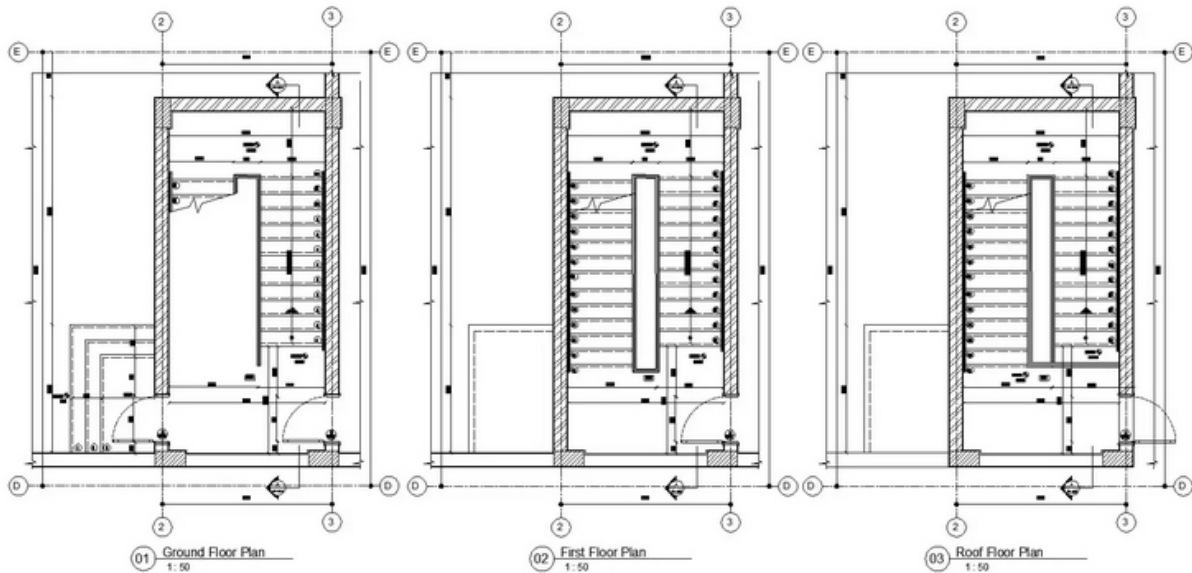

Floor plans of a typical exit stair. Note that there is a space between the door and the stair so when people are using the stair they don't get knocked over by someone opening the door.

Note UP and DOWN arrows on the stairs as they start at the floor you are drawing.

There is a "nosing" on the tread of around 20mm (part of the 255 tread dimension). This helps you not trip up the stairs. This is created regardless of what materials you are using to build the stair.



THE CHECKLIST

A way to be sure that you “have everything” on your drawings is to use a checklist. Each of the specific drawings will receive a checklist in this guide.

This checklist applies to all of your drawing sets.

AE BASIC DRAWING CHECKLIST

GENERAL NOTES	
Graphic clarity and uniformity in the set	
The contract is the drawing AND the notes	
Annotate thoroughly - prioritize notes over hatch	
Do not hatch dark or excessively it detracts from legibility	
Use industry standard hatches, do not improvise	
Make sure your notes align and do not create a chaotic visual	
Where possible, use assembly type labeling to limit spiderweb type arrows and assist clarity	
Be consistent - Metric OR Imperial, do not mix. In some cases both can be included but be consistent in how you order them.	
Generally material labels will include their thickness or size. Imagine taking these assembly lists to Home Depot and filling your order.	

Think of your drawing set as a set of instructions. A contractor could take these to Home Depot or Rona and know exactly what to pick up to build the building. They will go to the site and based on your measurements, set it out on the ground and put it up correctly.

SITE PLAN

The base drawing for most drawing sets is the Site Plan. It will show:

- Where your site is located, including
- Street names
- Adjacent neighbouring buildings
- North arrow
- Lines to show the property limits
- Significant vegetation such as large trees
- Pathways, roadways on the site
- Paved versus landscaped area
- Parking

The plan view of your building itself is normally a simple outline and doesn't include much detail.

SITE PLAN	
All about the location	
North Arrow	
Scale notation (numeric AND graphic)	
Plan of simplified ground floor of buildings	
Landscaping, trees, grassy areas, walkways	
Dotted lines to show limit of property size	
Partial plan of adjacent buildings if applicable	

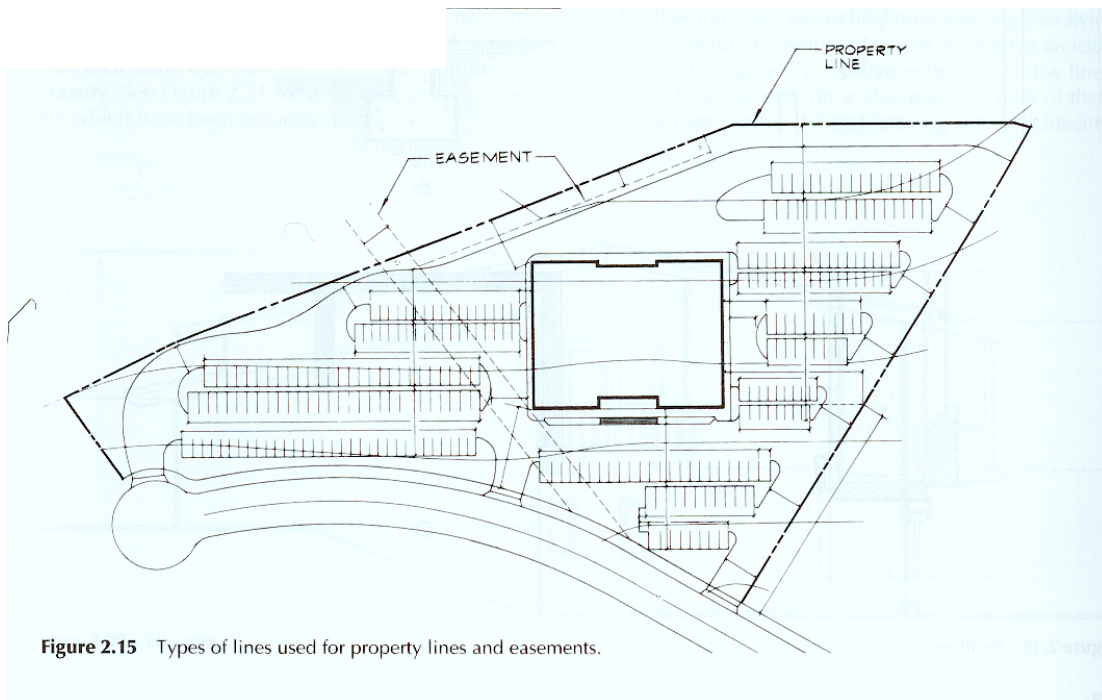

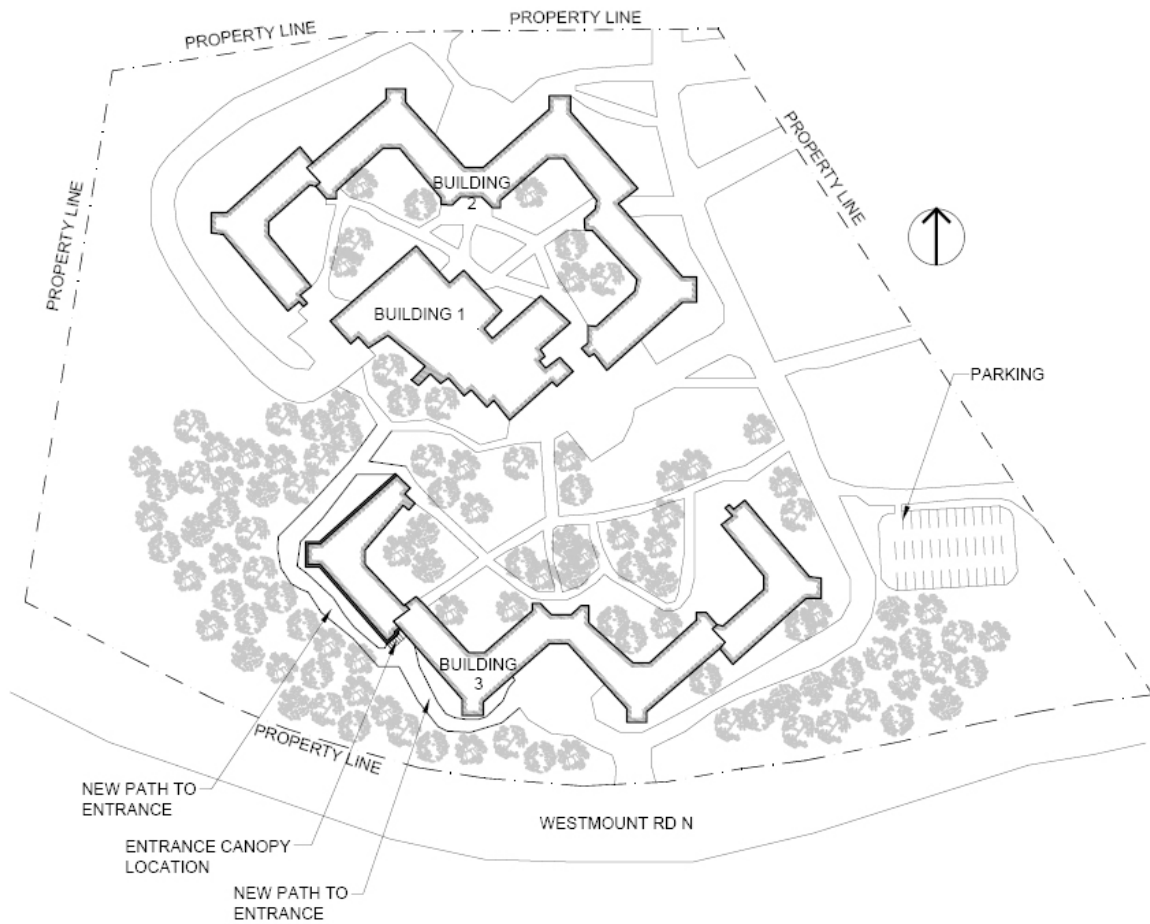

SITE PLAN 1
SCALE - 1:2000
UNITS - mm

Drawn by Renee Champion

There are different “special” lines used on site plans and property surveys.

- Property lines with the long double dash.
- Light dotted lines for easements (parts of the property that have utilities interfering either overhead or underground where you cannot build even if you own the land).

SURVEY DRAWING

The survey drawing is prepared by a registered Land Surveyor and provides you with accurate dimensions, site orientation for your north arrow and the setbacks for the adjacent buildings.

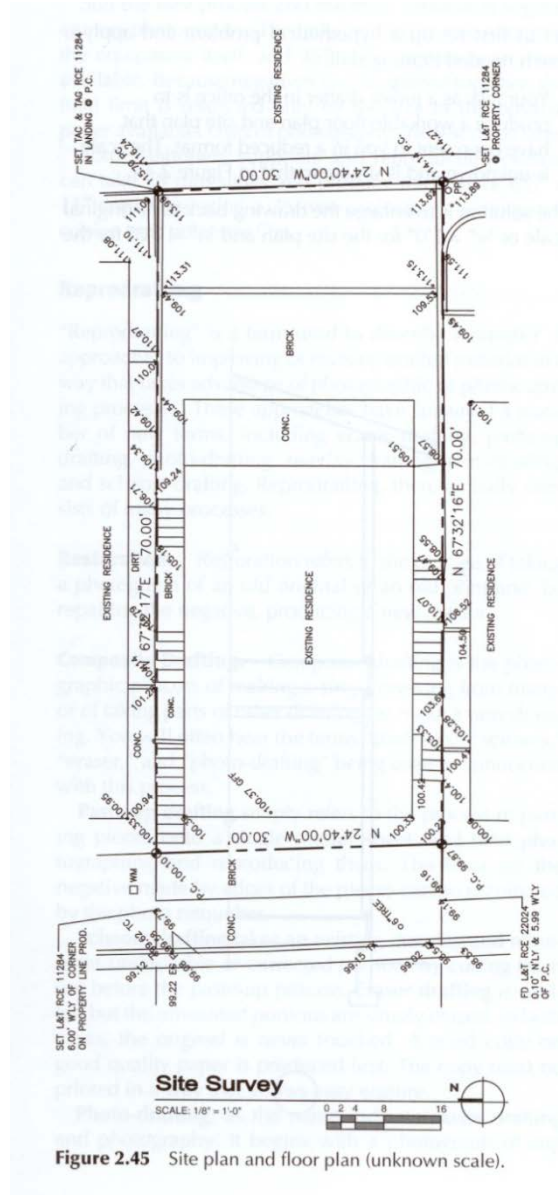

Architectural Working Drawings by Wakita and Linde

NORMAL PLAN VIEWS

Plans required for your drawing set will include Basement (if you have one), Ground Floor, Second and above and a Roof Plan. The drawing scale will vary based on the size of your building. Houses are usually drawn at 1:50 and larger commercial or institutional buildings at 1:100. **DO NOT INVENT ODD SCALES SO THAT THE DRAWING FITS ON THE PAGE.** After a time in the industry people can visualize these scales and so to make 1:75 or 1:25 plans is just confusing.

Special lines to include:

- Dotted lines to show what is happening overhead, including
- Roof overhangs
- Placement of roof ridges and valleys
- Mezzanines
- Open to above/double height spaces
- Skylights
- Gridlines if a column based building

PLANS (1:50 FOR SMALLER BUILDINGS, 1:100 FOR LARGER ONES)	
All about the walls, windows, doors, structural layout (columns)	
North Arrow	
Scale notation (numeric AND graphic)	
Label plan by floor level (Basement, Ground, Second, etc)	
Differentiated line weights emphasizing the exterior boundary of the wall elements	
Doors and door swings (public doors swing outward)	
Windows (no need to show operable but do include the frames and show the correct relationship to the insulation and exterior, show sills)	
Lines indicating the elements that make up the wall materials (for construction drawings - for design drawings these are normally filled in black)	
Dotted lines to indicate roof overhangs and ridge lines (if applicable, depends on the floor level)	
Dotted lines to show overhead openings, skylights, etc.	
For column based buildings, grid lines and bubbles	
Overall exterior dimension sets (amount depends on nature of the project)	
Indication of section cuts	
Hatch wall materials as appropriate to the scale you are working on (larger scale more detail here)	
Hatch floor materials very lightly if at all (don't detract from the wall information)	

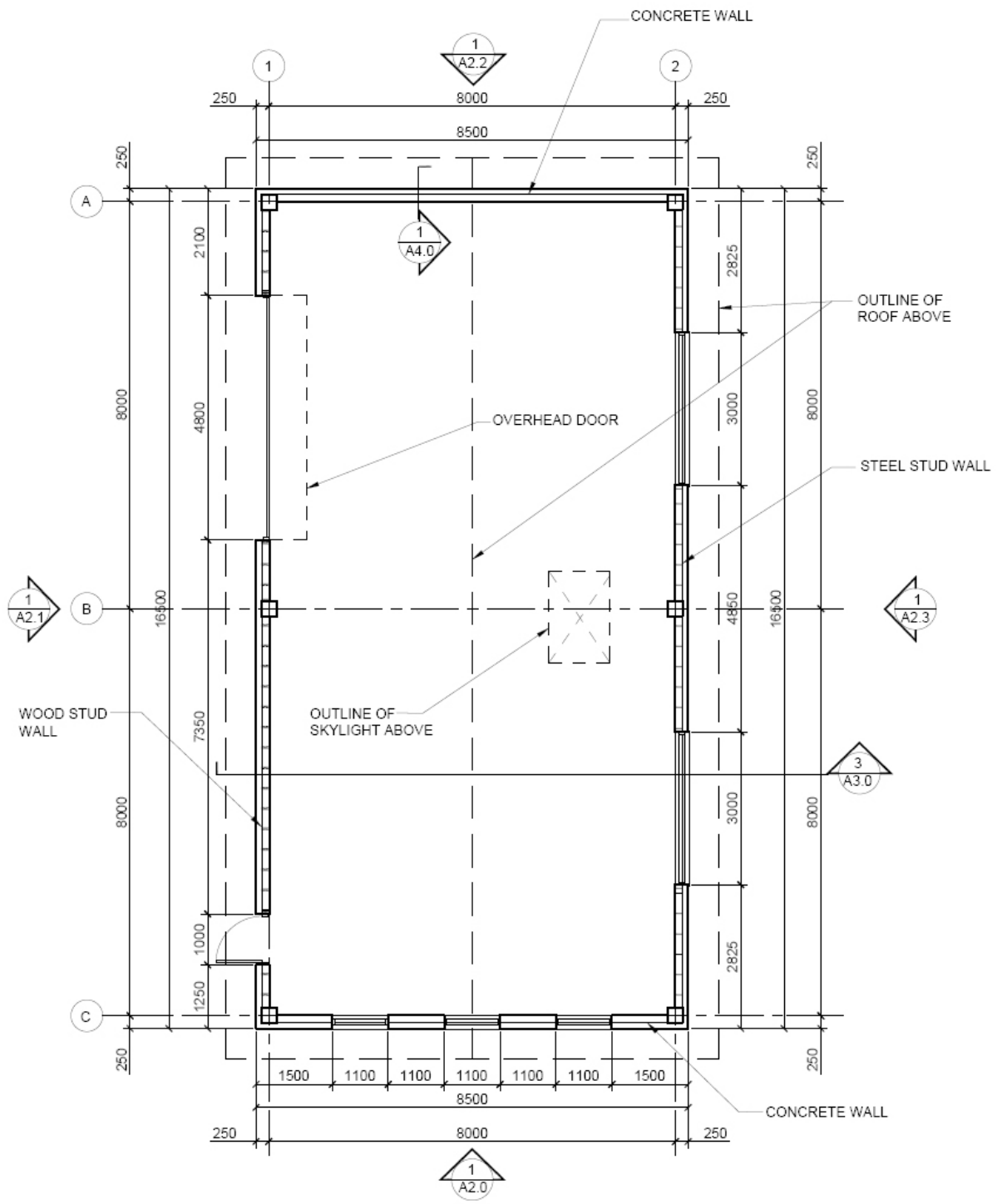

MAIN FLOOR PLAN 1
 SCALE - 1:100
 UNITS - mm

Drawn by Renee Champion

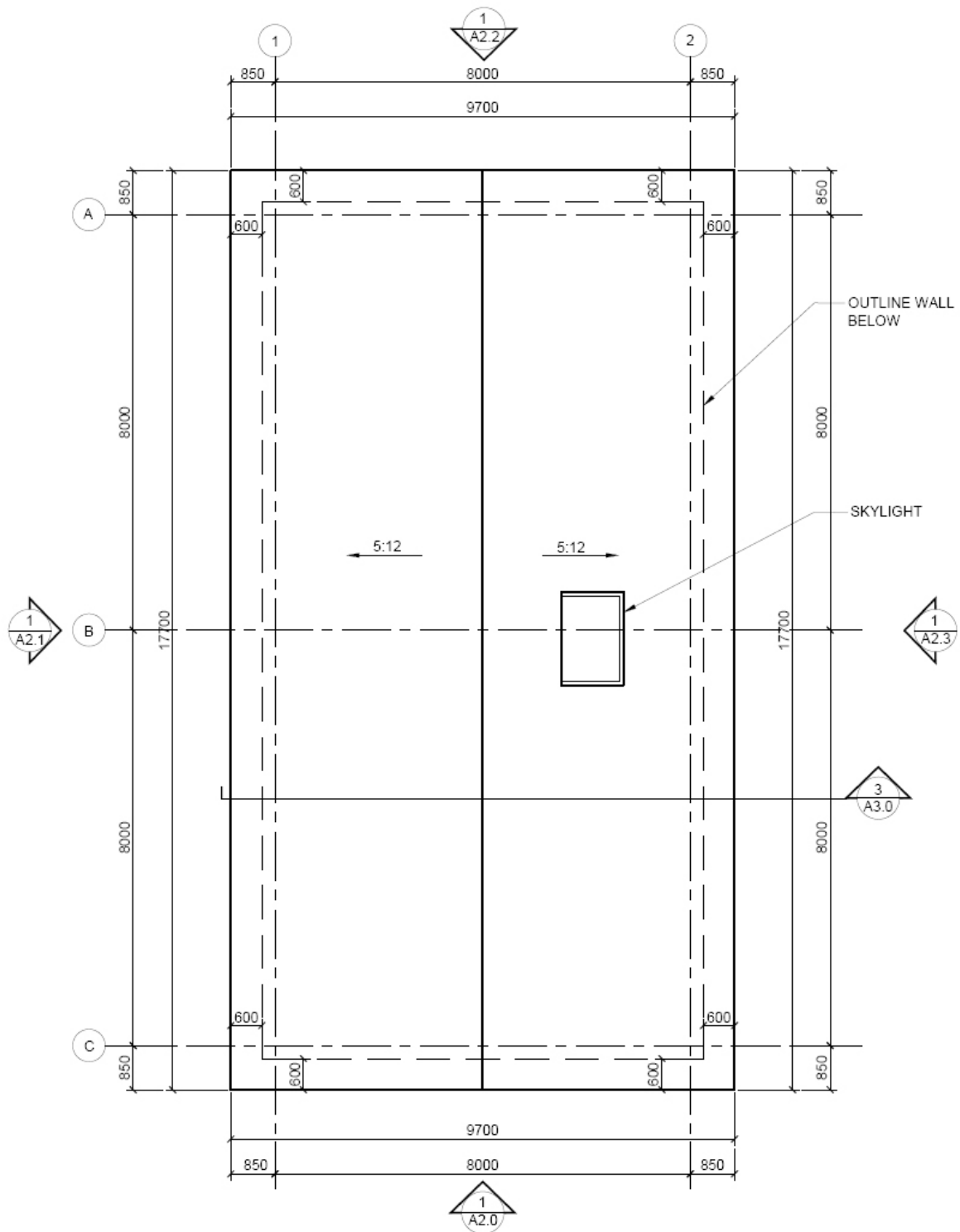

ROOF PLAN
SCALE - 1:100
UNITS - mm

1

Drawn by Renee Champion

STRUCTURAL FRAMING PLAN

Often there is simply too much information to put on the floor plans, making them tough to decipher. As the structural requirements form a unique set of criteria, and are often done by the engineer and not the architect, we usually create a separate plan to describe the details of the structure. This includes a drawing as well as a schedule describing the specific requirements of each member.

STRUCTURAL FRAMING PLAN (scale to match associated floor plan)	
This drawing is a very simplified plan view that clearly shows the structure of the framing of the building. The more architectural aspects of the plan are stripped away to make it clearer.	
North Arrow	
Scale notation (at least numeric)	
Label plan by floor level <u>that this structure supports</u>	
Indicate the elevation (datum) of the top surface of the structure (+3000mm, -1200mm etc)	
Grid lines and bubbles at primary column intersections and structural wall centerlines	
Dimension between grid lines	
indication of section cuts	
Thin lines to indicate the perimeter of a floor or roof surface	
Draw all structural members as diagrammatic lines along the centerline of each member	
- pull back the ends of the lines so that they are visibly short of what they connect into	
- use Super Thick and dash-dot lines for joists	
- use Super thick solid lines for beams and trusses	
- use a Thick outline for columns	
Draw all load bearing walls diagrammatically with a bold outline and an appropriate hatch inside (wood or concrete)	
Tag all structural members, use a short hand like T= truss, 1B = first floor beam, RB = roof beam, SW= shear wall, LBW = Load bearing wall add a unique number for each different unique type of member, i.e. T1 and T2 might be slightly different shapes, or support different loads, or have different support conditions	
- Label horizontal members (beams, trusses, joists, etc) beside the diagrammatic line, near the centre of the member, in the direction of the member.	
- Label vertical members (columns, posts, hangers, etc) with a tag that is placed on a 45 degree angle, as close to the edge of the member as possible	
- Label structural walls with a dimension line along their extents (βSW1->)	
Include a legend that shows what your tags mean. Structural Engineers include things like member size, length, material, maximum moment, camber, reaction on the left end, reaction on the right end, and comments	

MARK	TYPE	LENGTH	DIMENSION	COMMENTS
T1	DOUBLE HOWE TRUSS	8m	2.45m	SEE 5/S200 FOR ELEVATION
B1	D.FIR.L. GLULAM	8m	305x203mm	-
C1	D.FIR.L. GLULAM	4m	305x305mm	SEE SECTION 1/S400 FOR BASE DETAIL
SW1	REINFORCED CONCRETE	7.7m	250mm THICK	REINFORCED W/ 15M @ 300mm OC H&V

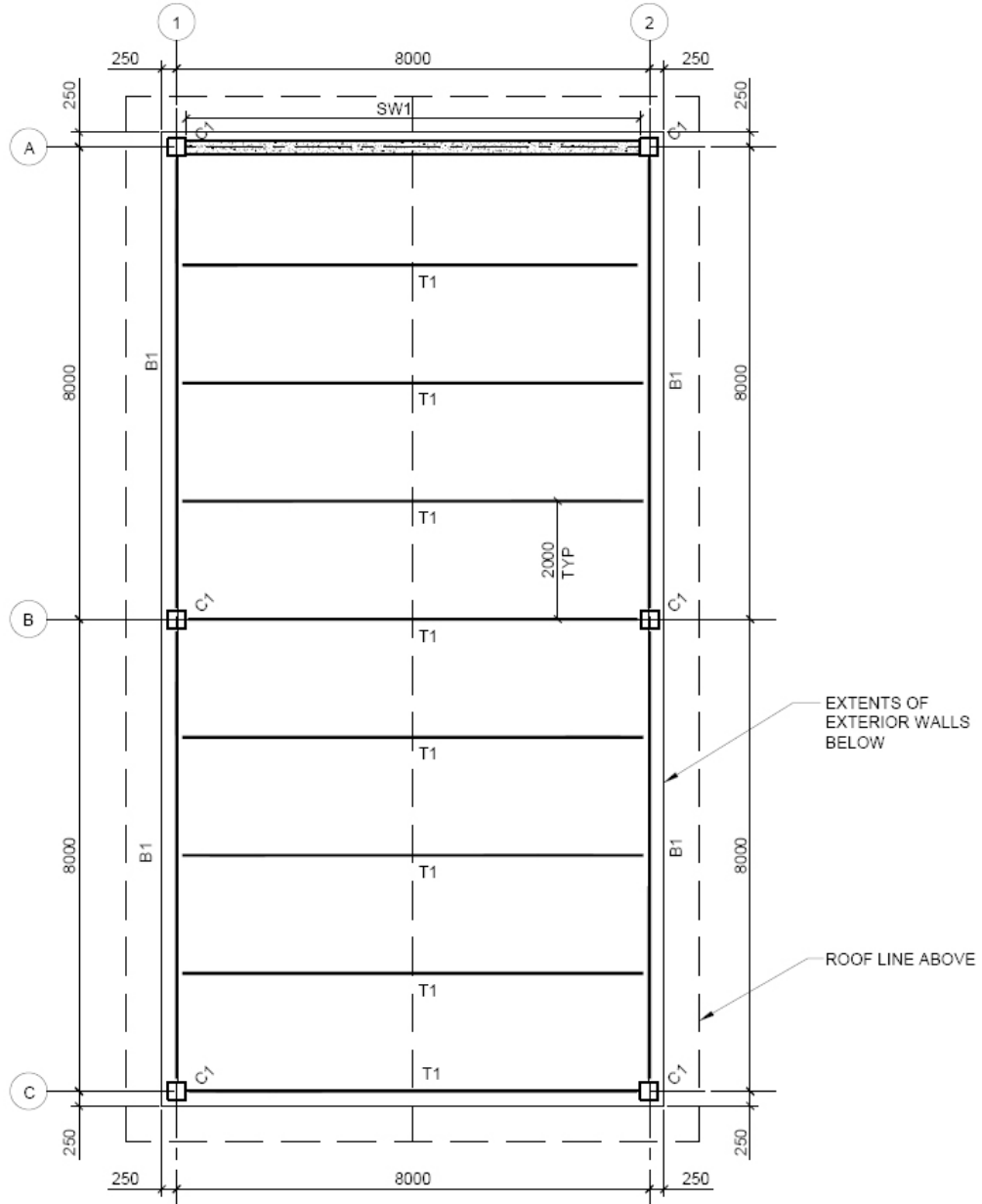

ROOF FRAMING PLAN 1
 SCALE - 1:100
 UNITS - mm
 U/S ROOF TRUSS = +4.15m

Drawn by Renee Champion

ELEVATIONS

Elevation drawings need to give information about the placement of windows and doors, materials and heights – including floor levels, basement levels, finished grade and roof heights.

The scale of the elevation drawing will match the scale of the plan drawings – so for residential usually 1:50 and for institutional or commercial 1:100. Always check that the drawings can fit on the page. For skyscrapers and the like other scales can be used.

On column based buildings with grids you will see the grids in the elevation.

ELEVATIONS (1:50 for smaller buildings, 1:100 for larger buildings)	
All about the exterior materials, glazing, heights	
NO North Arrow (irrelevant)	
Label elevations by cardinal direction (North, South, etc)	
Scale notation (numeric AND graphic)	
Accurately depict the arrangement of windows, doors and different façade materials	
Vary line weights. Outline entire building more heavily. Hatch is the lightest weight.	
Lightly hatch and <u>label</u> façade materials	
Indicate operability of doors and windows	
Dot in foundations and footings below grade	
Show vertical heights (note top of floor levels and roof/parapet top)	
Do NOT include any horizontal dimensions, those only go on the plan view	
Indication of section cuts	
Indication of column grid bubbles if applicable	

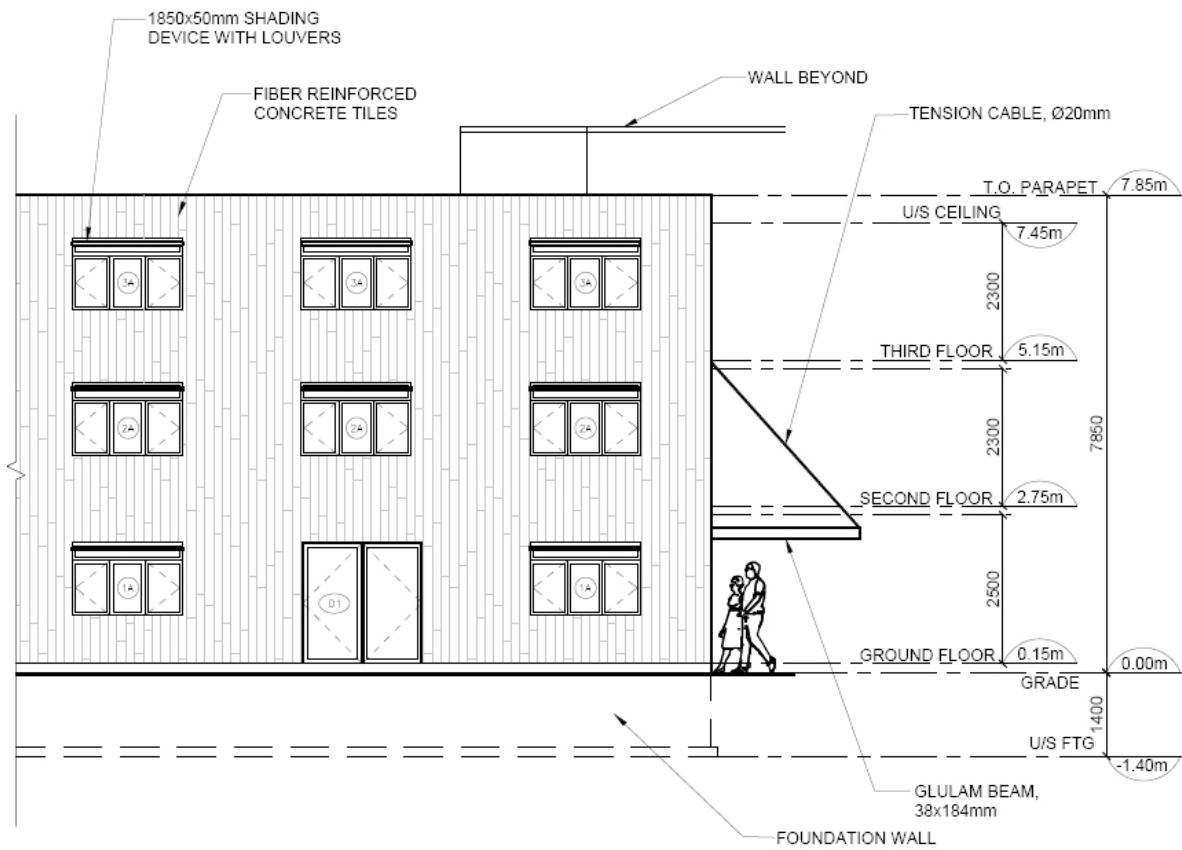

SOUTH ELEVATION
SCALE - 1:100
UNITS - mm

1

Drawn by Renee Champion

Make note on the elevation of the very light use of texture hatch, the dashed lines on the windows to indicate how they open, height lines, and a dotted line to show the foundation.

CROSS SECTIONS

Cross sections and longitudinal sections are drawn at the same scale as the elevations and plans, so 1:50 for residential and 1:100 for institutional and commercial.

You will see the layers of materials in the walls, floors and roof elements.

Very important to note floor heights as this drawing is used by the contractor to set these out during construction.

You can draw parts of the building that you can see in elevation beyond the section cut, but only using very light lines and no hatch in this area.

For very limited scope projects like houses or industrial buildings this drawing might be the only detail provided in section. For more complex projects you will also be drawing enlarged details to show exactly how things go together. The assumption for smaller buildings is that nothing very unique is happening and the builder knows how to do the work.

CROSS SECTIONS (1:50 for smaller buildings, 1:100 for larger buildings)	
The detail here is equal to the floor plan at 1:50. Less hatching than at a larger scale. Important to show heights and location of grid bubbles.	
NO North Arrow (irrelevant)	
Drawing titled clearly to match section cut indications on plan and elevations	
Vary line weights. Outside of section is darkest, hatch is lightest.	
Hatch materials with industry standard hatch.	
DO NOT hatch materials in elevation beyond.	
Label heights: bottom of footing, top of ground, second, etc floors, top of parapet, peak of roof (these are bubble to the side markers)	
Include dimension string outside the building to indicate window sill and head heights. These are attached to the bubble type markers mentioned above.	
Label all assemblies with assembly notation. (All different wall types, floor, ceiling, foundation)	

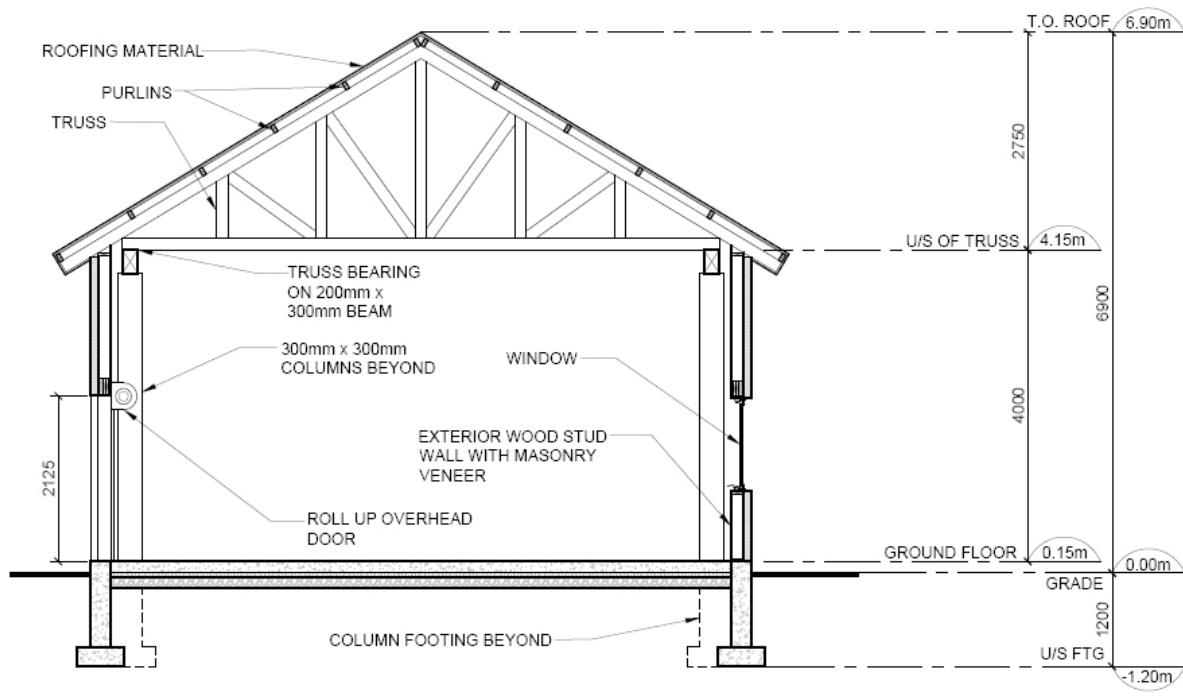

BUILDING SECTION 1
 SCALE - 1/75
 UNITS - mm

Drawn by Renee Champion

Typically the cross or longitudinal section cuts through the entire length of width of the building, from top to bottom, without "cuts".

WALL SECTIONS

Wall sections take the information presented in the Cross Section to an even higher level of detail as the scale of the drawing allows for much more detail to be shown.

Essentially base ingredients are the same as the cross section, except that this is taken through a single wall and goes from the bottom of the foundations to the peak of the roof or top of parapet.

All of the relevant floor heights are show. Additional vertical dimensions will locate the precise placement and height of all openings in the wall.

Where additional 1:5 details also form part of the set, use call-out bubbles to note the location of these details so that they can be cross referenced.

WALL SECTIONS (1:20 or 1:10)	
All about materials and details of how the foundations, floors, wall assemblies, windows, roof fit together. For smaller projects they will not produce details so this has to convey everything to the builder to build the project.	
NO North Arrow (irrelevant)	
Drawing titled clearly to match section cut indications on plan and elevations	
Vary line weights. Outside of section is darkest, hatch is lightest.	
Hatch materials with industry standard hatch.	
DO NOT hatch materials in elevation beyond.	
Label heights: bottom of footing, top of ground, second, etc floors, top of parapet, peak of roof (these are bubble to the side markers)	
Include dimension string outside the building to indicate window sill and head heights. These are attached to the bubble type markers mentioned above.	
If doing a renovation clearly indicate the existing structure as separate from new construction by using a light grey tone over this part. You don't call out all of these materials as they are already included in the building.	
Label all assemblies with assembly notation. (All different wall types, floor, ceiling, foundation)	
Put separate notes to unique elements in the wall.	
Arrange notes so that they are clear and do not criss-cross note lines	

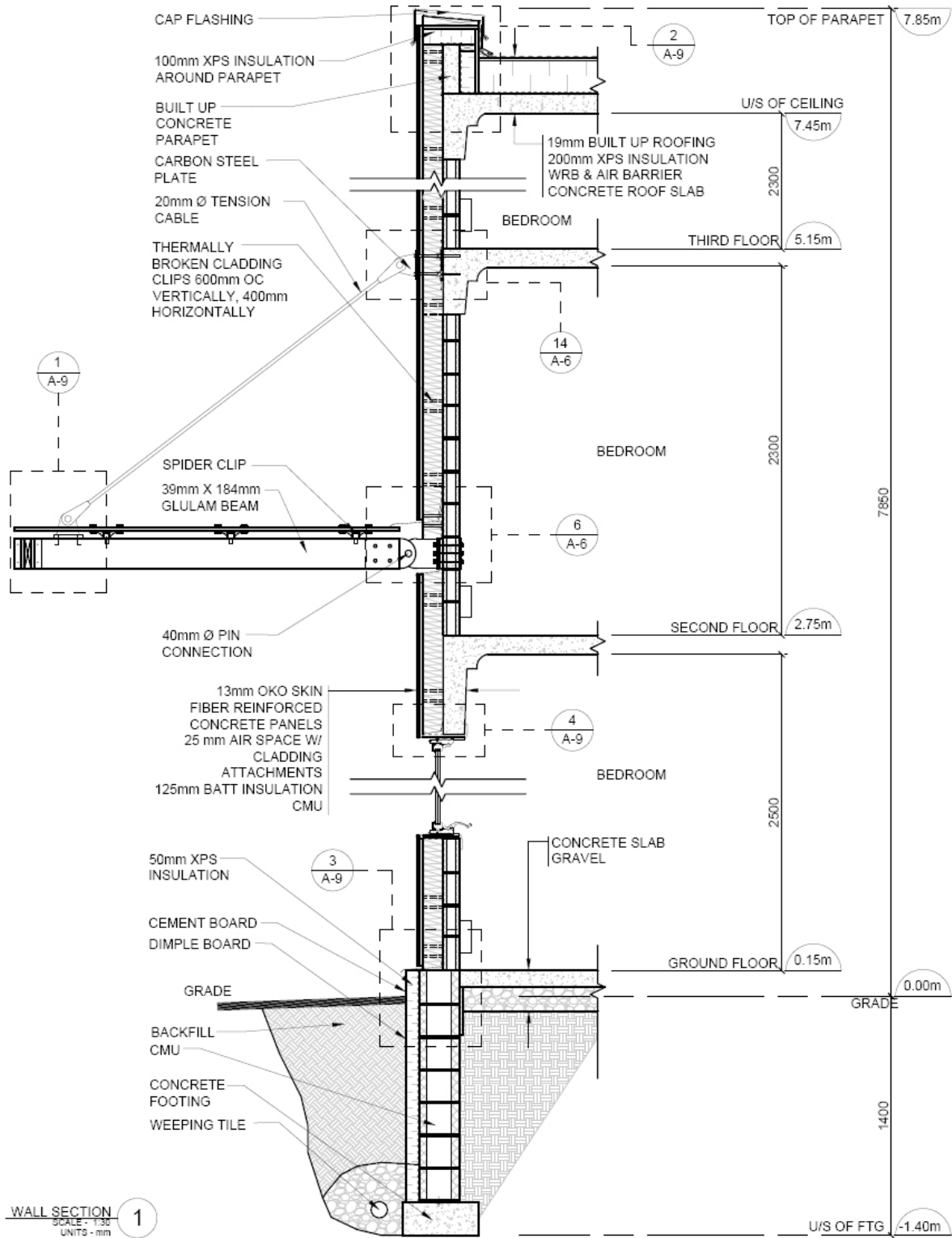

WALL SECTION 1
 SCALE - 1/32
 UNITS - mm

Drawn by Renee Champion

ENLARGED DETAILS

Where the construction gets very complicated or has some unique detailing additional details will be drawn at 1:5 scale to illustrate precisely how these work. Additional notes and dimensions as well as material specifications will be added. You will often use the previous section drawings as the base for this enlarged detail, but will add information not in the previous drawing.

These details can be plan view as well as section views.

ENLARGED DETAILS (1:5 OR 1:10)	
These will ADD more detail beyond what is already shown in the 1:20 drawing. Connections, membranes, flashing. Things that you cannot possibly draw/see clearly at 1:20.	
Detail views can be section or plan in nature	
Drawing titled to match callout on 1:20 section (or floor plan)	
Differentiated line weights, hatch being the lightest.	
Begin by enlarging the 1:20 version to the correct scale and start to fill in with more detail.	
Add connection information, membranes, flashing, likely a bit more hatching.	
<i>Include the assembly notes from the 1:20 as these are often read separately by the contractor</i>	
Include the grid bubble and section heights associated with the detail.	
Add labels to indicate all of the new material info added. Include thicknesses.	
Be specific about materials. These form the basis of the order list made by the contractor. Need to know what kind of rigid insulation. What sort of membrane? They vary a lot.	
Add dimensions that relate the position of material changes to the structure, gridlines, floor heights, etc.	

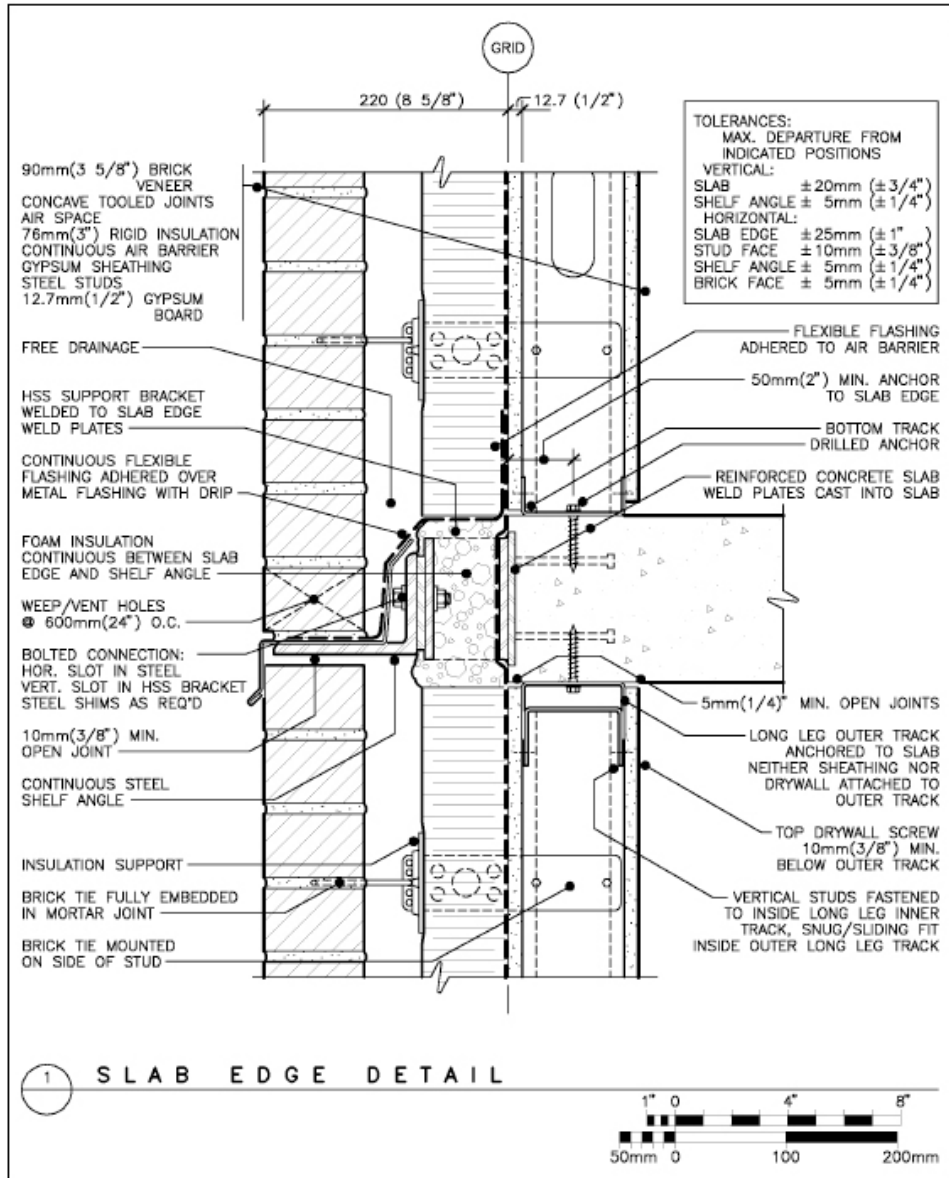

Detail 1: Slab Edge

In a well -developed detail this is the level of information you are expecting to convey Note how the exterior lines have been darkened to help to punch out the drawing. The hatch is evident but not overpowering. The text is all lined up. All of the attachment mechanisms are shown.

Dashed lines are really important to show membrane continuity!

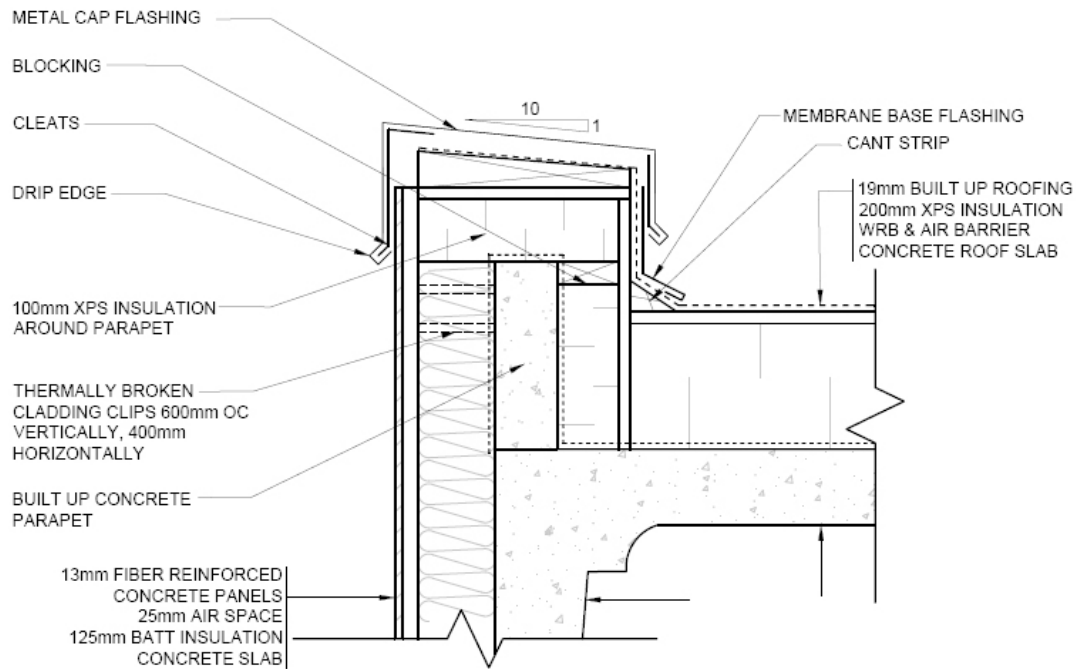

ROOF TO WALL CONNECTION DETAIL 1
SCALE - 1:10
 UNITS - mm

Drawn by Renee Champion

Make sure that you thoroughly label the adjacent assemblies of the walls and roof. The contractor doesn't want to go hunting around the entire drawing set to locate and understand this information.

RENDERINGS

There are various ways to make 3D views of your project, some faster than others. An isometric or axonometric is a quick way to create a 3D drawing by hand.

The isometric requires that you redraw the plan with a 30° angle from the base line so that it looks like a diamond shape (top left). The vertical lines are all to scale and it looks almost like a perspective.

The axonometric (top right) uses the actual plan to project the vertical lines. It can be placed 30° , 60° or 45° to the base line, depending how you want it to look. The vertical lines are actual dimensions.

You can also make a projected drawing using the elevation (bottom center).

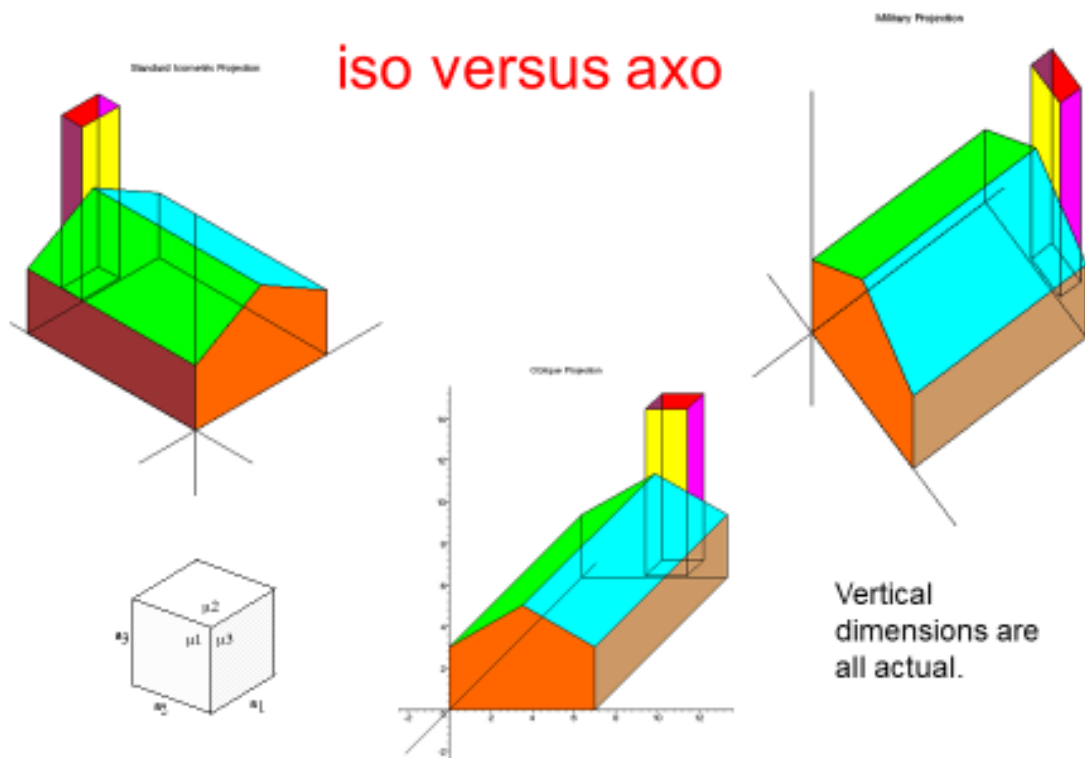

STRUCTURAL 3D VIEWS

It is often helpful to explain your structural system using a 3D view of just the skeleton of the building, cladding stripped away.

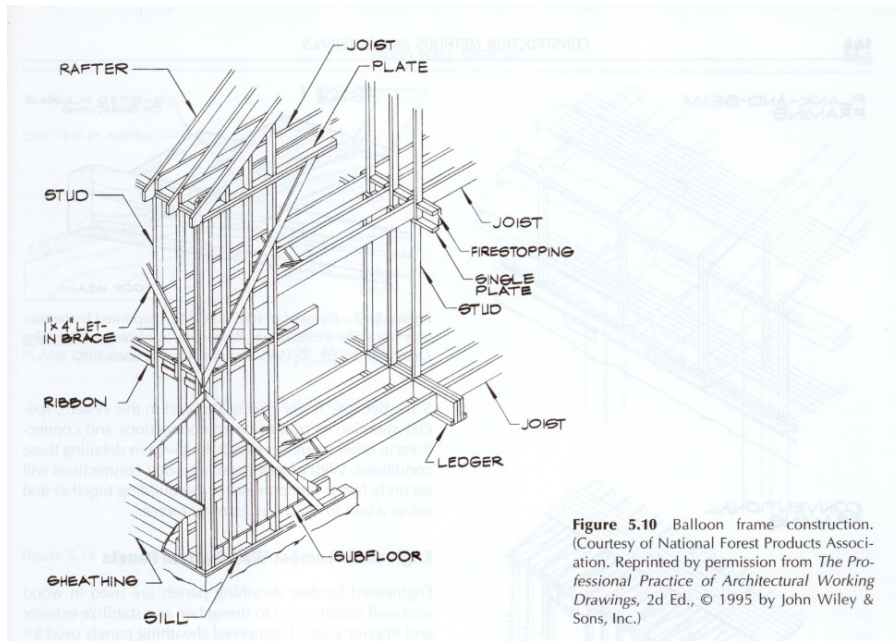

Architectural Working Drawings by Wakita and Linde

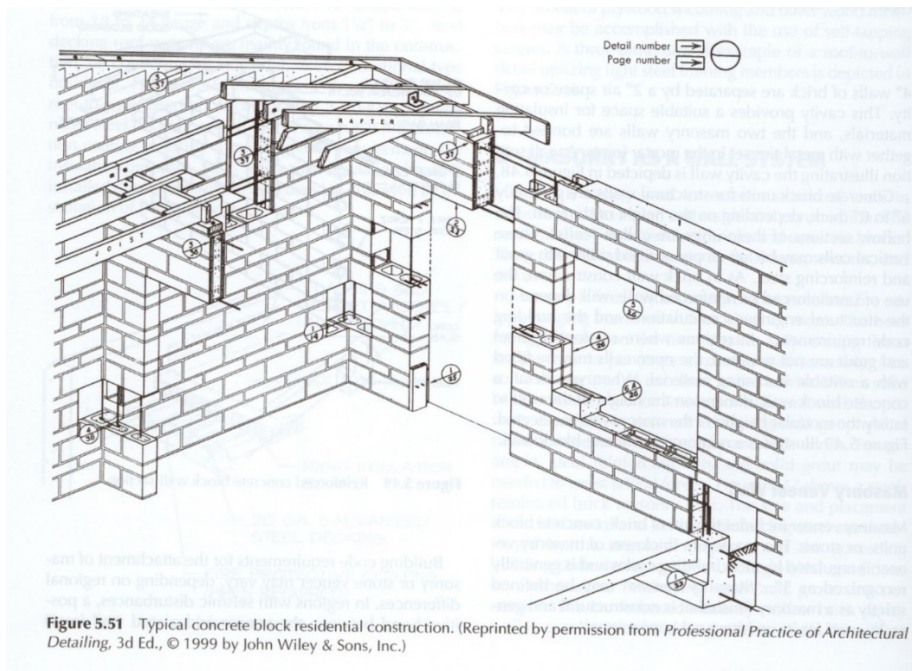

Architectural Working Drawings by Wakita and Linde

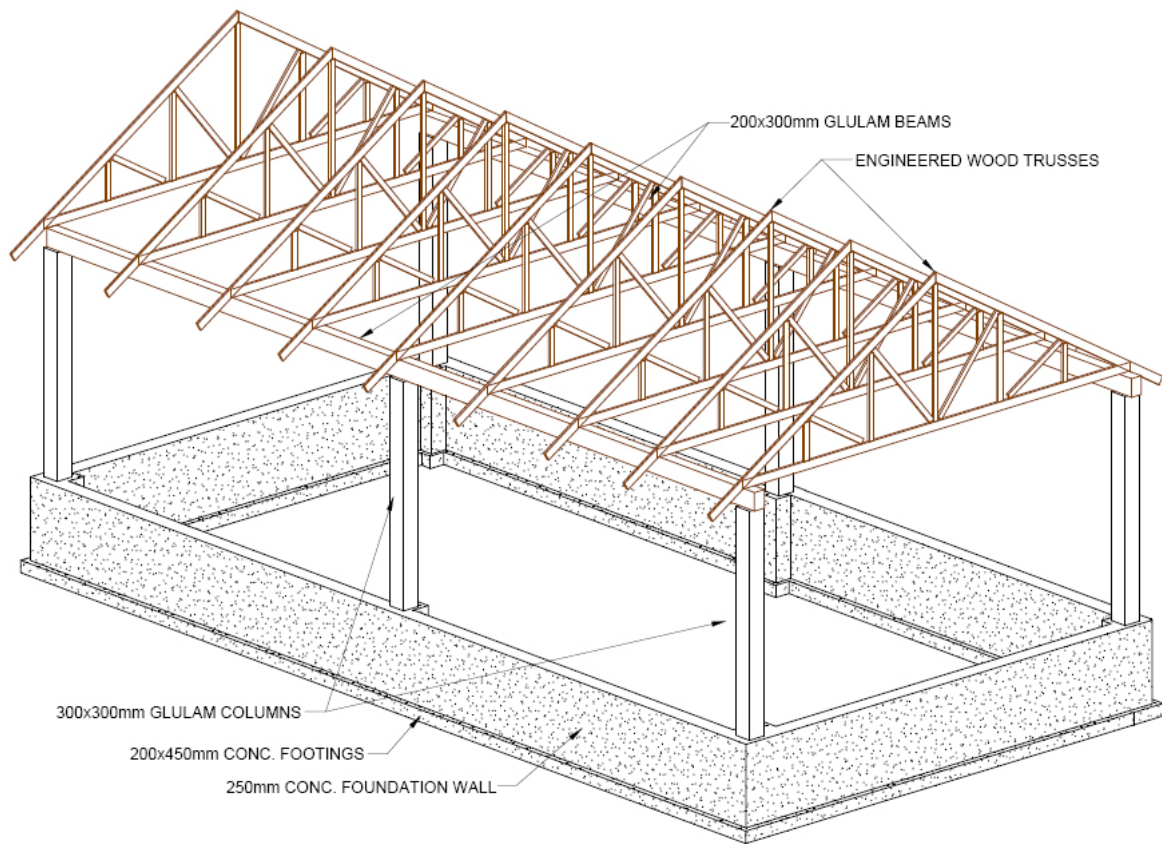

STRUCTURAL AXONOMETRIC
SCALE - NTS
UNITS - mm

1

Drawn by Renee Champion

A structural axonometric is a great way to strip down a project and show an understanding of the major structural elements so that you can discern or explain your loadpaths and the spacing of your columns and spanning members.

ONE POINT PERSPECTIVE

Hand drawing an accurate perspective is a big task, but you can quickly rough up a simple one point perspective using a method developed by Leon Battista Alberti in the Renaissance.

It starts from taking the actual plan, with a central vanishing point, and arbitrarily setting the rear line of the (in this case square) plan to make a trapezoid. All of the other lines are projected from this base. It isn't entirely accurate, but can give you a quick interior perspective.

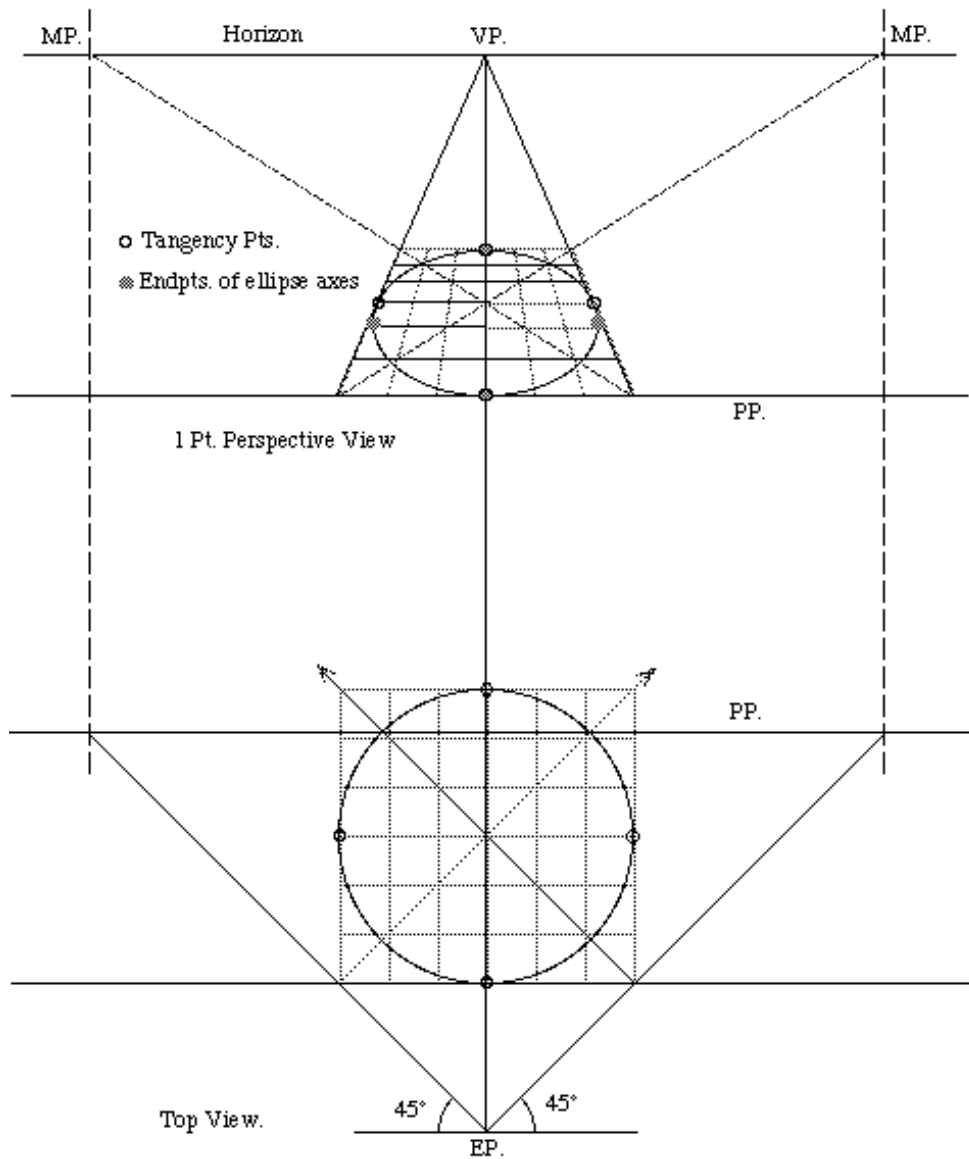

As can be seen in this version of the Alberti Method, every line is extrapolated from the skewed plan that forms the base of the drawing. The measurements at the “front” are to scale.

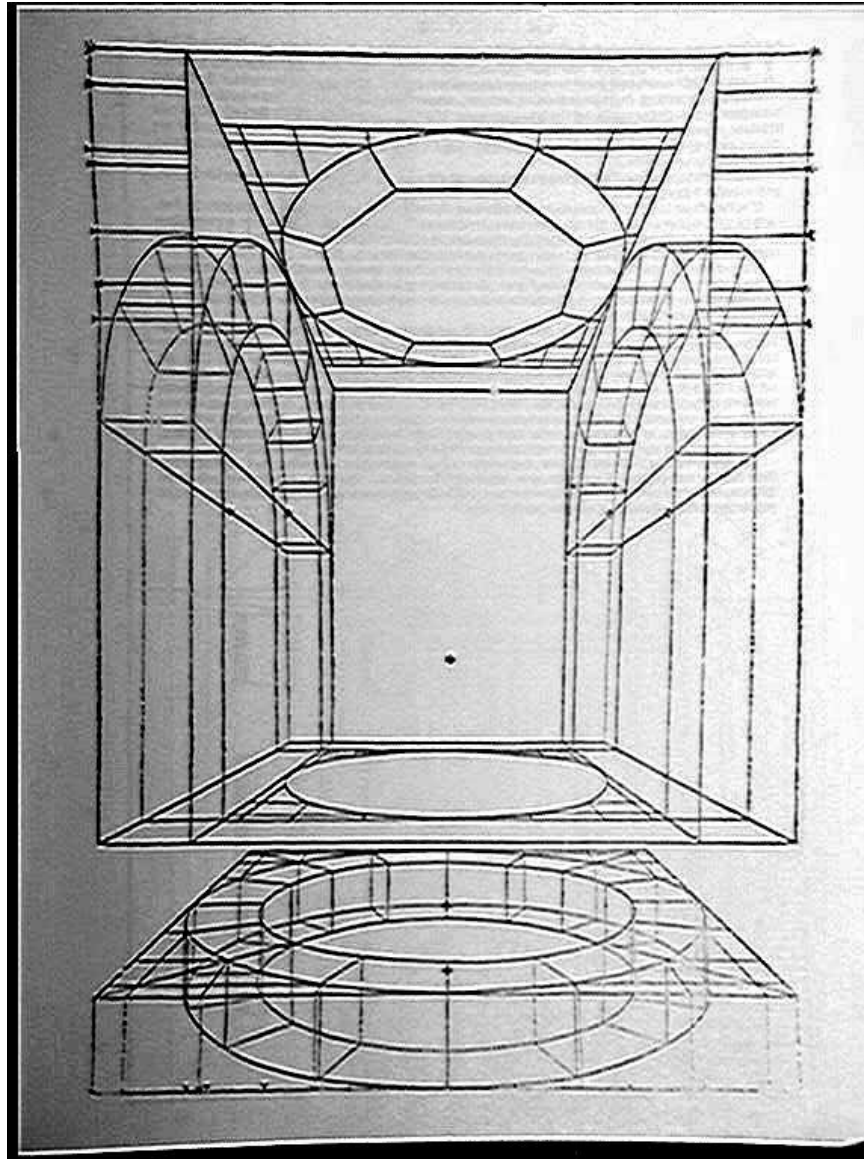

Sebastiano Serlio's Five Books of Architecture